

# 335F L

Hydraulic Excavator

2017



## Engine

Engine Model	Cat® C7.1 ACERT™	
Gross Power – SAE J1995	152 kW	204 hp
Net Power – SAE J1349	149 kW	200 hp

## Drive

Maximum Travel Speed	4.2/2.6 km/h	2.6/1.6 mph
Maximum Drawbar Pull	295 kN	66,319 lbf

## Weight

Minimum Operating Weight	34 330 kg	75,680 lb
Maximum Operating Weight	38 180 kg	84,170 lb

## Introduction

*The new Cat 335FL is the largest compact radius machine available from any major manufacturer today. The type of up-close, space-restricted work you can do with such a unique, heavy-duty machine is nearly unlimited.*

*Powered by a new fuel-efficient C7.1 ACERT engine that meets U.S. EPA Tier 4 Final/ EU Stage IV emission standards, the machine comes equipped with roughly 17,000 pounds of counterweight out back, durable structures built for a lifetime of service, and a state-of-the-art hydraulic system that puts all the energy in your hands so you can move tons of material – literally – all day long with tremendous stability, speed, and precision.*

*When you add in standard high-ambient cooling along with an available cold weather package, a full-size ROPS cab that keeps you comfortable and productive, easy-to-reach service points that make your routine maintenance fast and simple, and multiple Cat work tools and tool control options that help you take on a variety of tasks, you simply won't find a better, more versatile 35-ton excavator – one more than capable of working year round on any project, any place, anywhere.*

## Contents

Compact Radius .....	4
Integrated Technologies .....	5
Hydraulics .....	6
Engine .....	8
Operator Station .....	10
Front Linkage .....	12
Structures & Undercarriage .....	13
Attachments .....	14
Serviceability .....	16
Safety .....	17
Complete Customer Care .....	18
Sustainability .....	19
Specifications .....	20
Standard Equipment .....	32
Optional Equipment .....	33





**If your business calls for a tool-carrying machine that can take on several tight-quarter tasks like loading trucks without swinging into traffic, picking and placing heavy materials, and even taking down structures to make way for progress, you need the versatile Cat 335F L in your fleet. In this size class, there simply isn't anything like it. In fact, it's in a class of its own.**



# Compact Radius

Work with greater confidence in tight quarters

### Less Tail

The demand for excavators capable of working in tight quarters continues to grow, and Caterpillar is meeting the need – from the mini 301.7D CR all the way up to the new 335F L. The market’s largest compact radius machine will help you take on some of the heaviest up-close work with confidence knowing you won’t hit a wall or an oncoming vehicle when you swing because it has only six inches of overhang.

### More Stability

The 335F L utilizes the long, heavy-duty undercarriage from the large 336F excavator. Measuring 5020 mm (16’6”), this platform provides much greater stability when lifting heavy objects, which leads to greater overall productivity.

### Better Lift

The 335F L is designed to deliver greater lift capability out front and over the side than the model it’s replacing. Two major contributors are increased hydraulic pressure and flow.

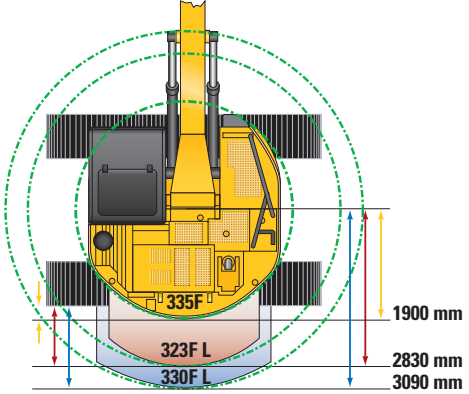

# Integrated Technologies

Monitor, manage, and enhance your job site operations



## Cat Connect

The smart use of technology and services will improve your job site efficiency. In fact, using data from technology-equipped machines gives you more information and insight into your equipment and operations than ever before.

## LINK Technologies

LINK technologies like Product Link™ wirelessly connect you to your equipment, giving you valuable insight into how your machine or fleet is performing. The system tracks location, hours, fuel usage, productivity, idle time, and diagnostic codes through the online VisionLink® interface so you can make timely, fact-based decisions to maximize efficiency, improve productivity, and lower operating costs.



# Hydraulics

Power to move your material with speed and precision



## Ground-Breaking Design

When it comes to moving heavy material quickly and efficiently, you need hydraulic horsepower – the type of ground-breaking power the 335F L can deliver. Major hydraulic components like the main pump and main control valve are located close together so shorter tubes and lines can be used. This design leads to less friction loss, reduced pressure drops, greater fuel efficiency, and more power to the ground for the work you need to get done.

### **Control Like No Other**

Controllability is one of the key attributes of Cat excavators, and one of the main contributors to this is the main control valve. The valve opens slowly when your joystick lever movement is small and opens rapidly when movement is high. It directs flow where you need it when you need it, which leads to smoother operation, greater efficiency, and lower fuel consumption.

### **Tool Control Above The Others**

Caterpillar's standard tool control system gives you just the right amount of pressure you need to work with a variety of tools, including rotating grapples, shears, and multiprocessors. Unique to Cat machines is the ability for you to pre-program up to 10 different tools through the machine's monitor to make switching for the job at hand simple and easy to do, which will save you time and money compared to other brands' manual systems.

### **Auxiliary Hydraulics For Added Versatility**

Auxiliary hydraulic circuits give you added versatility, and there are several factory-installed options from which you can choose. You can have a single function circuit to run a hammer and compactor or a double function circuit to run a thumb or tilt bucket. A quick coupler circuit allows you to switch from one tool to another in a matter of minutes – all from the comfort and convenience of the cab.

### **Boom & Stick Oil Re-Circulation For Added Efficiency**

The 335F L regenerates the flow of oil from the head end of the boom and stick cylinders to the rod end of the boom and stick cylinders during the work cycle to save energy and improve fuel efficiency. It's optimized for any dial speed setting you select, which results in less pressure loss for higher controllability, more productivity, and lower operating costs for you.



# Engine

Powerful and fuel efficient to meet your expectations



## Proven Technology

Every Tier 4 Final/Stage IV ACERT engine is equipped with a combination of proven electronic, fuel, air, and aftertreatment components. Applying these time-tested technologies lets us meet your high expectations for productivity, fuel efficiency, reliability, and service life. Following are the results you can expect:

- **Improved fuel efficiency**, with minimized Diesel Exhaust Fluid (DEF) consumption.
- **High performance** across a variety of applications.
- **Enhanced reliability** through commonality and simplicity of design.
- **Maximized uptime and reduced cost** with world-class Cat dealer support.
- **Minimized impact** on emission systems – with no operator interaction required.
- **Durability** with long service life.
- **Better fuel economy** with minimized maintenance costs.
- **Same great power** and response.



## **Fuel Savers That Add Up**

The 335F L consumes up to 16% less fuel than the D Series model it's replacing, and lowering engine speed without impacting production is one of the key contributors. Automatic engine speed control also contributes by lowering rpm when the machine doesn't need it for work. Automatic engine idle shutdown turns the engine off when it's been idling for more than a specified amount of time that you can set through the monitor. Plus you have a choice of three power modes – high power, standard power, and eco mode. Simply change between modes through the console switch panel to meet the work needs in front of you. Collectively, all of these benefits add up to lower fuel consumption, less exhaust and sound emissions, reduced repair and maintenance costs, and increased engine life for you.

## **A Cool Design For Any Temperature**

The machine's cooling system is built to work in extreme conditions. The system is completely separated from the engine compartment to reduce noise and heat. Plus it features easy-to-clean cores and a variable-speed fan that runs only when needed to ensure maximum efficiency.

## **Biodiesel Not A Problem**

The C7.1 ACERT engine can run on up to B20 biodiesel that meets ASTM 6751 standards – all to give you more potential fuel-saving flexibility.

## **More Powerful, Reliable Engine Electronics**

Cat Tier 4 Final/Stage IV engine electronics are more powerful and robust than ever, enhancing your experience and increasing quality and reliability through the most demanding applications.

## **Next Generation Fuel Systems**

Injection timing precisely controls the fuel injection process, which provides more control of combustion for the cleanest, most efficient fuel burn. To maximize your value, Caterpillar engineers specified fuel systems based on the power and performance demands for each engine. The high-pressure common rail fuel system with full electronic injection improves precision and control, reducing soot and boosting the engine's performance.

## **Innovative Air Management**

Cat Tier 4 Final/Stage IV engines feature innovative air management systems that optimize airflow and enhance power, efficiency, and reliability. A range of simple, reliable turbo charging solutions based on engine size and application allows us to match turbo performance to rated output for high productivity, excellent fuel efficiency, long life, and low operating costs for you.

## **Cat NO<sub>x</sub> Reduction System**

The Cat NO<sub>x</sub> Reduction System captures and cools a small quantity of exhaust gas and then routes it back into the combustion chamber to drive down temperatures and reduce NO<sub>x</sub> emissions. The result of more than a decade of Caterpillar engineering research into this technology is the most reliable system of its type.

## **Aftertreatment Technologies**

The aftertreatment solution utilized for Tier 4 Final/Stage IV products is the next evolutionary step for Cat engines with ACERT Technology. To meet the additional 80% reduction in NO<sub>x</sub> emissions required by Tier 4 Final/Stage IV emission standards, Caterpillar engineers only needed to add one new system to the already proven aftertreatment solution in use, Selective Catalytic Reduction (SCR).

## **Diesel Exhaust Fluid (DEF)**

Cat engines equipped with an SCR system inject DEF into the exhaust to reduce NO<sub>x</sub> emissions. DEF is a precisely mixed solution of 32.5% high purity chemical grade urea and 67.5% de-ionized water. DEF used in Cat SCR systems must meet the requirements outlined in the International Organization for Standardization (ISO) standard 22241-1. ISO 22241-1 requirements are met by many brands of DEF, including those that carry the AdBlue or API certifications.

## **An Emissions Solution That Works**

The Cat C7.1 ACERT engine meets Tier 4 Final/Stage IV emission standards, and it does so without interrupting your job process. Simply turn the engine on and go to work.

# Operator Station

Comfort and convenience to keep you productive





### **A Safe, Quiet Cab**

The ROPS cab provides you with a safe working environment. It also contributes to your comfort because it's attached to a reinforced frame with special viscous mounts that limit vibration and unnecessary sound. Add in special roof lining and sealing and you have a cab that's as quiet inside as today's top pickup trucks.

### **Comfortable Seat Options**

The seat range includes air suspension, heated, and air cooled options. All seats include a reclining back, upper and lower slide adjustments, and height and tilt angle adjustments to meet your needs for maximum comfort.

### **A Cool & Warm Environment**

The automatic climate control system features multiple air outlets with filtered ventilation. Air flows on the floor, behind the seat, and in front of you to make your work in either hot or cold weather much more pleasant and productive.

### **Controls Just For You**

The right and left joystick consoles can be adjusted to improve your comfort and productivity during the course of a day. Also, the right joystick features a button that will reduce engine speed when you are not working to help save fuel. Touch it once and speed reduces; touch it again and speed increases for normal operation.

### **A Helpful Monitor**

The LCD monitor is easy to see and navigate. Programmable in up to 44 languages to meet today's diverse workforce, the monitor clearly displays critical information you need to operate efficiently and effectively. Plus it projects the image from the standard rearview camera to help you see what's going on around you so you can stay safely focused on the job at hand.

### **Ample Storage & Auxiliary Power**

Storage spaces are located in the front, rear, and side consoles of the cab. A drink holder accommodates a large mug, and a shelf behind the seat stores large lunch or toolboxes. Two 12-volt power supply sockets are conveniently located near the key storage areas for charging your electronic devices like an MP3 player, a cell phone, or a tablet.



# Front Linkage

Options to take on your far-reaching and up-close tasks

## Booms & Sticks

The 335F L is offered with a 6.15 m (20'2") reach boom and a range of sticks. Each is built with internal baffle plates for added durability, and each undergoes ultrasound inspection to ensure weld quality and reliability. Large box-section structures with thick, multi-plate fabrications, castings, and forgings are used in high-stress areas such as the boom nose, boom foot, boom cylinder, and stick foot to improve durability. The boom nose pin is a captured flag design for enhanced durability.

## Great Lengths For Your Work

The 335F L comes with a 6.15 m (20'2") reach boom and choice of three stick options that offer you excellent all-around versatility. Longer sticks are better when you need to dig deep or load trucks. Shorter sticks provide greater breakout force and increase your productivity when using hydromechanical work tools.

Following are the three stick length options:

- The 3.75 m (12'4") stick provides maximum reach. It is an ideal choice for deep trenching applications like water and sewer line installation.
- The 3.2 m (10'6") stick delivers greater digging forces and higher bucket capacities than the longer stick option while still providing an excellent working envelope.
- The 2.65 m (8'8") stick produces the highest digging and lifting forces and largest bucket capacity; it also provides stability for hammer applications.

Talk to your Cat dealer to pick the best front linkage for your specific line of work.

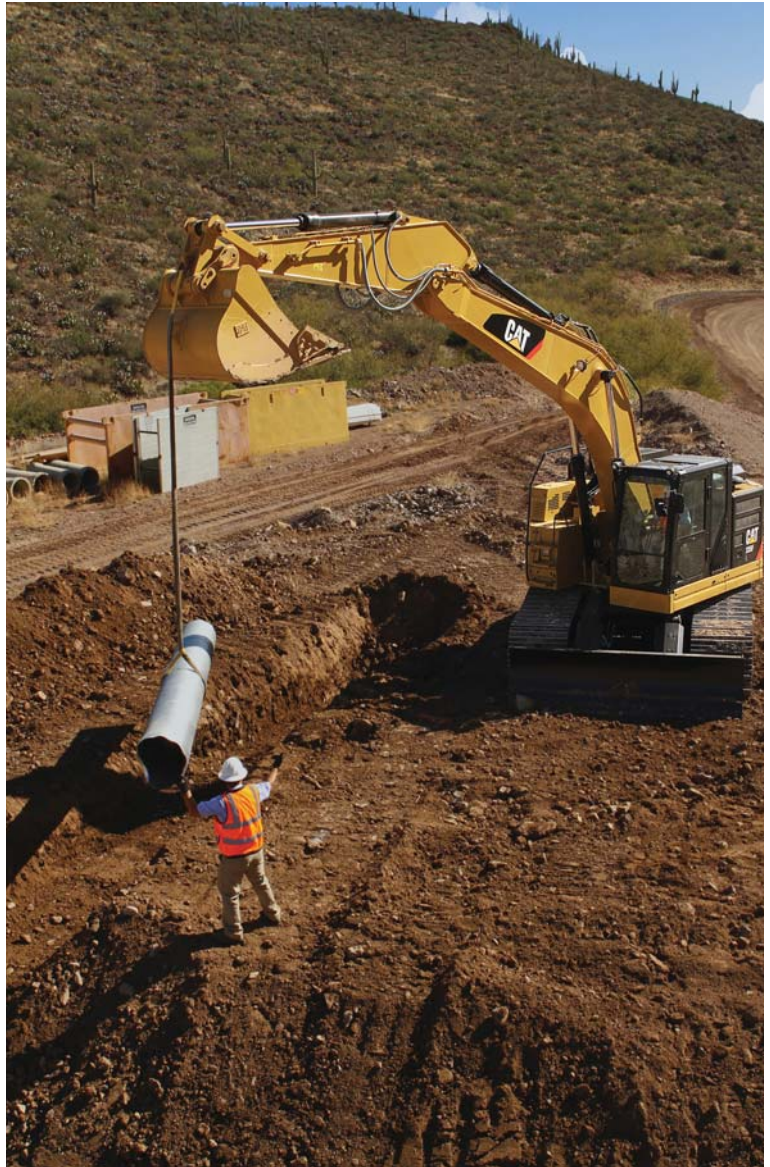



## Structures & Undercarriage

Designed to work in your rugged applications

### Robust Frame

The 335F L is a well-built machine designed to give you a very long service life. The upper frame has mountings made specifically to support the heavy-duty cab; it is also reinforced around key areas that take on stress like the boom foot and skirt. Massive bolts are used to attach the track frames to the body, and additional bolts are used to increase the machine's digging force, which leads to more productivity for you.

### Durable Undercarriage

The 335F L undercarriage contributes significantly to its outstanding stability and durability. Track shoes, links, rollers, idlers, and final drives are all built with long-lasting, high-tensile-strength steel. Cat Grease Lubricated Track 2 (GLT2) track link protects moving parts by keeping water, debris, and dust out and grease sealed in, which delivers longer wear life and reduced noise when traveling. Optional guide guards help maintain track alignment to improve the machine's overall performance – whether you're traveling on a flat, heavy bed of rock or a steep, wet field of mud.

### Heavy Counterweight

A 7.7 mt (16,975 lb) heavy counterweight is available. Built with thick steel plates and reinforced fabrications to make it less susceptible to damage, the weight has curved surfaces that match the machine's sleek, smooth appearance along with an integrated housing to help protect the standard rearview camera.



# Attachments

Tools to make you productive and profitable

## Get The Most Out Of One Machine

You can easily expand the performance of your machine by utilizing any of the variety of attachments offered by Cat Work Tools.

## Change Jobs Quickly

A quick coupler brings the ability to quickly change attachments and switch from job to job. The Cat Pin Grabber coupler is the secure way to decrease downtime and increase job site flexibility and overall productivity.

## Balance & Back Fill

An optional blade provides enhanced stability, which comes in handy when working with smaller shoes. It can also be used to backfill light material.

## Dig, Finish, Load & Compact

A wide range of buckets dig everything from top soil to harsh, abrasive material. For finishing and grading work, compact and shallow ditch cleaning buckets fit the need. A Cat compactor prepares the area for the next phase of construction.

## Break, Demolish & Scrap

A hydraulic hammer equips your machine for breaking rock in quarries and preparing trenches on construction sites. Taking down bridge pillars and heavily reinforced concrete is no problem. Multi-processor, pulverizer, and shear attachments take your machine into structure demolition jobs and process the debris for reuse and recycle.

## Move & Handle

Add a thumb and you have the ability to move and handle brush, rocks, and debris. For constant material handling, a grapple is your solution. Choose from three different styles for picking, sorting, and loading trash, demolition debris, or recyclables.

## Set Up Your Machine For Profitability

Your Cat dealer can install hydraulic kits to properly operate all Cat Work Tool attachments – maximizing the machine's uptime and your profits. All Cat Work Tool attachments are supported by the same Cat dealer network as your Cat machine.

**GRAB, SORT, LOAD**



**Pro Series Hydraulic Thumbs**



**Stiff Link Thumbs**



**Contractors' Grapples**



**Trash Grapples**

**SWAP TOOLS**



**Pin Grabber Coupler**

**DIG & PACK**



**Ditch Cleaning and Tilt Buckets**



**General Duty Buckets**



**Heavy Duty Buckets**



**Severe Duty Buckets**



**Vibratory Plate Compactors**

**CUT, CRUSH, BREAK & RIP**



**Multi-Processors**



**Scrap & Demolition Shears**



**Secondary Pulverizers**



**Hydraulic Hammers**



**Rippers**

# Serviceability

Designed to make your maintenance quick and easy

## Safe, Convenient Access

You can reach most routine maintenance items like fluid taps and grease points from the safety and convenience of ground level. You will also find filters banked together for higher service efficiency. Compartments feature wide service doors designed to help prevent debris entry, and they also securely latch in place to help make your service work simpler. The engine hood features a gas cylinder to assist to make opening and closing easy.

## A Cool Design

The high-ambient cooling system features a fuel-saving variable-speed fan and a side-by-side-mounted radiator and oil and air coolers for easy cleaning. Wider clearance between the two makes blowing off debris easy for you, which can help improve your machine's reliability and performance.

## A Fresh Idea

When you select ventilation inside the cab, outside air enters through the fresh air filter. The filter is conveniently located on the side of the cab to make it easy to reach and replace, and it is protected by a lockable door that can be opened with the engine key.

## More Service Benefits

The DEF tank is conveniently located beneath a lockable door. Filters are banked together to enhance service efficiency. The fuel tank's drain cock makes it easy and simple for you to remove water and sediment during routine maintenance. Plus an integrated fuel level indicator pops up to help you reduce the possibility of fuel tank overfilling.





# Safety

Features to help protect you day in and day out

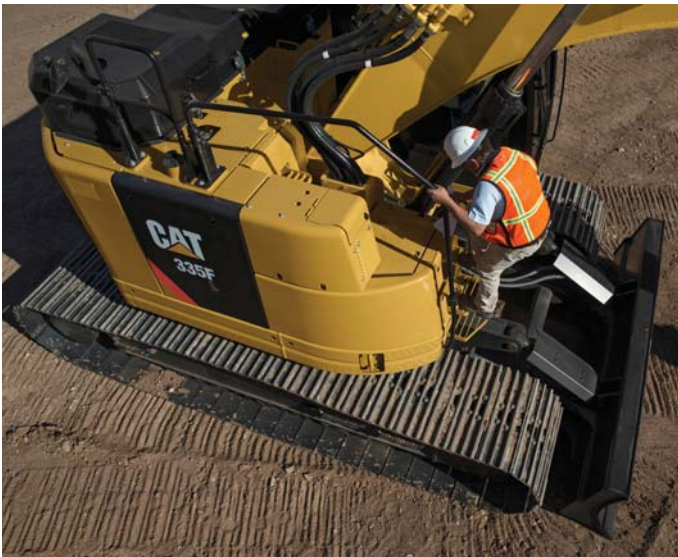

## A Safe, Quiet Cab

The ROPS cab provides you with a safe working environment when properly seated and belted. It also contributes to your comfort because it's attached to a reinforced frame with special viscous mounts that limit vibration and unnecessary sound. Add in special roof lining and sealing and you have a cab that's as quiet inside as any of today's top pickup trucks.

## Secure Contact Points

Multiple large steps get you into the cab as well as a leg up to the compartments. Extended hand rails allow you to safely climb to the upper deck. Anti-skid plates reduce your slipping hazards in all types of weather conditions, and they can be removed for cleaning.

## Great Views

Ample glass gives you excellent visibility out front and to the side, and the standard rearview camera gives you a clear field of view behind the machine through the cab monitor. The available split-configuration windshield features an upper window with handles that make it easy to slide and store above you and a lower window that can be removed and stored on the inside wall of the cab. The large skylight also serves as an emergency exit and provides you with enhanced overhead visibility.

## Smart Lighting

Halogen lights provide plenty of illumination, and the cab and boom lights can be programmed to stay on for up to 90 seconds after the engine has been turned off to help you safely exit the machine.

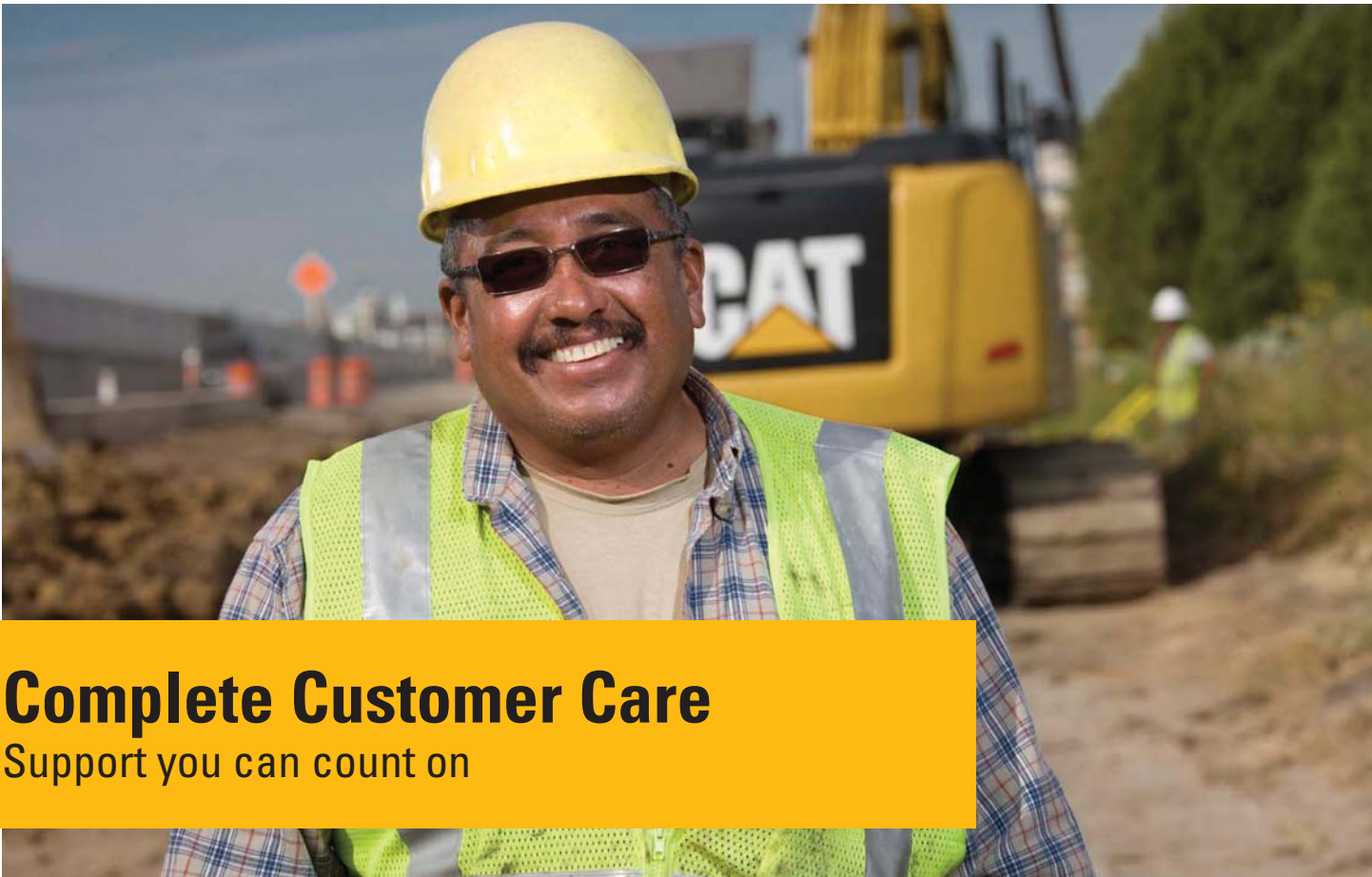

# Complete Customer Care

Support you can count on

### **Worldwide Parts Availability**

Cat dealers utilize a worldwide parts network to maximize your machines' uptime. Plus they can help you save money with Cat remanufactured components.

### **Advice You Can Trust**

What are the job requirements and machine attachments? What production is needed? Your Cat dealer can provide recommendations to help you make the right machine choices.

### **Financial Options Just For You**

Consider financing options and day-to-day operating costs. Look at dealer services that can be included in the machine's cost to yield lower owning and operating costs over time.

### **Support Agreements To Fit Your Needs**

Cat dealers offer a variety of customer support agreements and work with you to develop a plan to meet your specific needs. These plans can cover the entire machine, including attachments, to help protect your investment.

### **Operating Techniques To Boost Your Profits**

Improving operating techniques can boost your profits. Your Cat dealer has videos, literature, and other ideas to help you increase productivity. Caterpillar also offers simulators and certified operator training to help maximize the return on your investment.

### **What's Best For You Today... And Tomorrow**

Repair, rebuild, or replace? Your Cat dealer can help you evaluate the cost involved so you can make the best choice for your business.

# Sustainability

Generations ahead in every way



- The C7.1 ACERT engine meets Tier 4 Final/Stage IV emission standards.
- The 335F L burns 16% less fuel than the Tier 3/Stage IIIA 328D model it replaces, which means less emissions.
- The machine has the flexibility of running on either ultra-low-sulfur diesel fuel (ULSD, with 15 ppm of sulfur or less) or biodiesel fuel up to B20 blended with ULSD.
- A ground-level overfill indicator rises when the tank is full to help the operator avoid spilling.
- The machine is built to be rebuilt with major structures and components capable of being remanufactured to reduce waste and replacement costs.
- Overall, the 335F L is an efficient, productive machine that's designed to conserve our natural resources for generations ahead.

# 335F L Hydraulic Excavator Specifications

## Engine

Engine Model	Cat C7.1 ACERT	
Net Power – SAE J1349	149 kW	200 hp
Gross Power – SAE J1995	152 kW	204 hp
Engine rpm		
Operation	1,800 rpm	
Travel	1,800 rpm	
Bore	105 mm	4.13 in
Stroke	135 mm	5.31 in
Displacement	7.01 L	428 in <sup>3</sup>

- Power rating at 1,800 rpm.

## Weights

Minimum Operating Weight*	34 330 kg	75,680 lb
Maximum Operating Weight**	38 180 kg	84,170 lb

\*Long undercarriage, 600 mm (24 in) TG track, reach boom, R2.65CB2 (8'8") stick, CB2 bucket linkage and CB1233HD 1.3 m<sup>3</sup> (1.7 yd<sup>3</sup>) bucket.

\*\*Long undercarriage, 850 mm (33 in) TG track, blade, reach boom, R3.75 m (12'4") stick, CB2 bucket linkage, CB1350HD 1.54 m<sup>3</sup> (2.01 yd<sup>3</sup>) bucket.

## Track

Standard with Long Undercarriage	850 mm	33 in
Optional for Long Undercarriage	600 mm	24 in
Number of Shoes Each Side – Long Undercarriage	49	
Number of Track Rollers Each Side – Long Undercarriage	9	
Number of Carrier Roller Each Side	2	

## Swing Mechanism

Swing Speed	9.9 rpm	
Maximum Swing Torque	105 kN·m	77,350 lbf-ft

## Drive

Maximum Gradeability	35°/70%	
Maximum Travel Speed	4.2/2.6 km/h	2.6/1.6 mph
Maximum Drawbar Pull	295 kN	66,319 lbf

## Hydraulic System

Main System		
Maximum Flow (Total)	494 L/min	130 gal/min
Implement × 2 pumps	246.6 L./min	65.1 gal/min
Swing system – Maximum Flow		
No swing pump		
Maximum Pressure – Equipment – Normal		
		35 000 kPa 5,076 psi
Maximum Pressure – Travel		
		37 000 kPa 5,366 psi
Maximum Pressure – Heavy Lift		
		38 000 kPa 5,512 psi
Maximum Pressure – Swing		
		27 400 kPa 3,974 psi
Pilot System Maximum Flow		
		30 L/min 7.9 gal/min
Pilot System Maximum Pressure		
		4100 kPa 595 psi
Boom Cylinder – Bore		
		140 mm 5.5 in
Boom Cylinder – Stroke		
		1407 mm 55.4 in
Stick Cylinder – Bore		
		150 mm 5.9 in
Stick Cylinder – Stroke		
		1646 mm 64.8 in
Bucket Cylinder (CB) – Bore		
		150 mm 5.9 in
Bucket Cylinder (CB) – Stroke		
		1151 mm 45.3 in

## Service Refill Capacities

Fuel Tank Capacity	385 L	101.7 gal
Cooling System	30 L	7.9 gal
Engine Oil	24 L	6.3 gal
Swing Drive (each)	9 L	2.4 gal
Final Drive (each)	8 L	2.1 gal
Hydraulic System (including tank)	290 L	76.6 gal
Hydraulic Tank	154 L	40.7 gal
DEF Tank	23 L	6.1 gal

## Sound Performance

ISO 6395 (External)	104 dB
ISO 6396 (Inside Cab)	72 dB

- When properly installed and maintained, the cab offered by Caterpillar, when tested with doors and windows closed according to ANSI/SAE J1166OCT98, meets OSHA and MSHA requirements for operator sound exposure limits in effect at time of manufacture.
- Hearing protection may be needed when operating with an open operator station and cab (when not properly maintained or doors/windows open) for extended periods or in a noisy environment

## Standards

Brakes	ISO 10265:2008
Cab/FOGS	ISO 10262:1998 Level II
Cab/ROPS	ISO 12117-2:2008

# 335F L Hydraulic Excavator Specifications

## Dimensions

All dimensions are approximate.

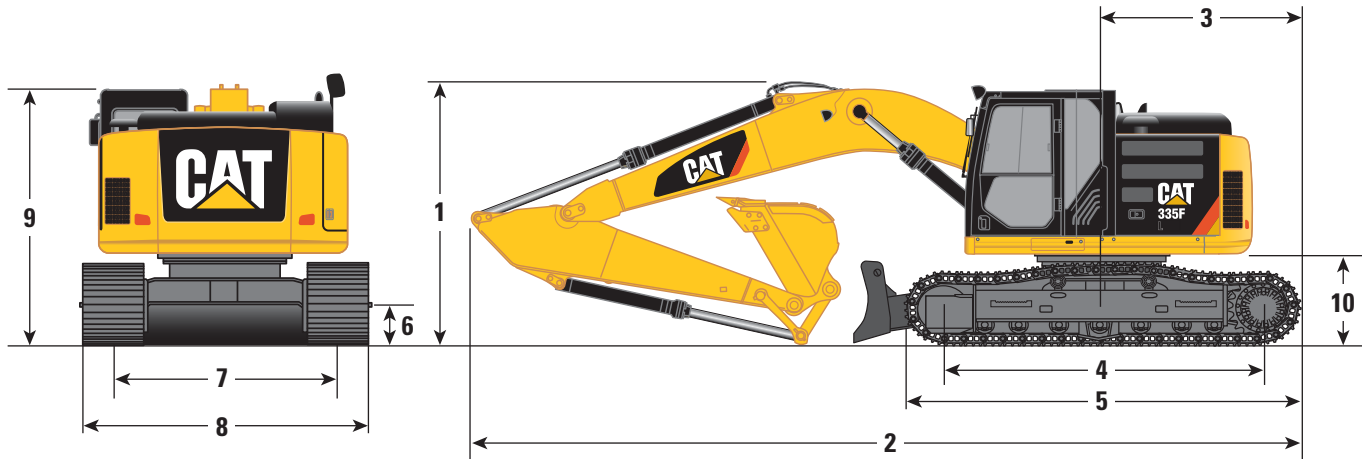

### Boom Options

### Reach Boom 6.15 m (20'2")

Stick Options	R3.2CB2 (10'6")***		R2.65CB2 (8'8")***		R3.75CB2 (12'4")****	
<b>1</b> Shipping Height*	3540 mm	11'7"	3540 mm	11'7"	3650 mm	12'0"
<b>2</b> Shipping Length	9820 mm	32'3"	9830 mm	32'3"	9870 mm	32'5"
<b>3</b> Tail Swing Radius	1900 mm	6'3"	1900 mm	6'3"	1900 mm	6'3"
<b>4</b> Length to Center of Rollers – Long Undercarriage	4040 mm	13'3"	4040 mm	13'3"	4040 mm	13'3"
<b>5</b> Track Length – Long Undercarriage	5020 mm	16'6"	5020 mm	16'6"	5020 mm	16'6"
<b>6</b> Ground Clearance**	480 mm	1'7"	480 mm	1'7"	480 mm	1'7"
<b>7</b> Track Gauge – Long Undercarriage	2590 mm	8'6"	2590 mm	8'6"	2590 mm	8'6"
<b>8</b> Transport Width – Long Undercarriage						
600 mm (24 in) Shoes	3190 mm	10'6"	3190 mm	10'6"	3190 mm	10'6"
850 mm (33 in) Shoes	3440 mm	11'3"	3440 mm	11'3"	3440 mm	11'3"
<b>9</b> Cab Height*	3260 mm	10'8"	3260 mm	10'8"	3260 mm	10'8"
<b>10</b> Counterweight Clearance**	1200 mm	3'11"	1200 mm	3'11"	1200 mm	3'11"

\*Including shoe lug height

\*\*Without shoe lug height

\*\*\*Bucket 331-1907 1.54 m<sup>3</sup> (2.01 yd<sup>3</sup>)

\*\*\*\*Bucket 331-1906 1.31 m<sup>3</sup> (1.70 yd<sup>3</sup>)

# 335F L Hydraulic Excavator Specifications

## Working Ranges

All dimensions are approximate.

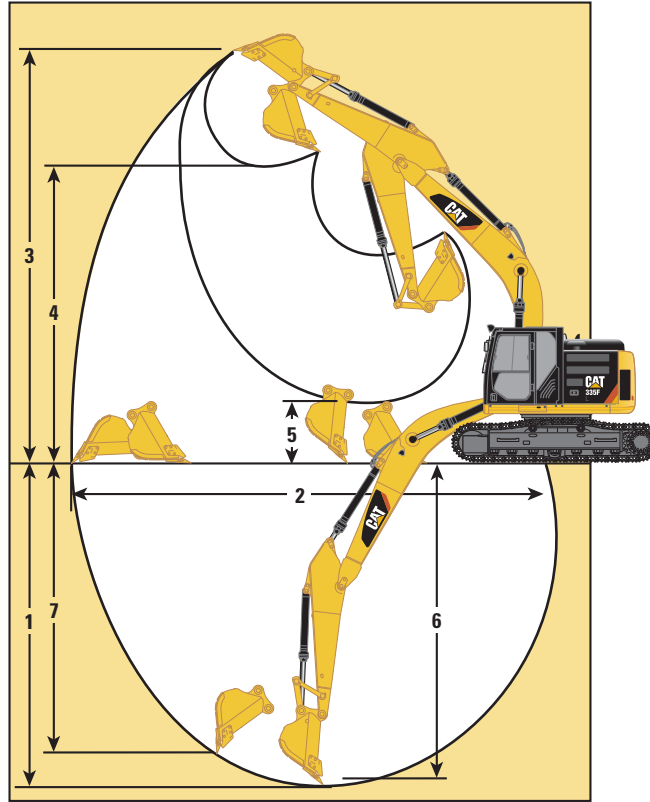

### Boom Options

**Reach Boom  
6.15 m (20'2")**

### Stick Options

**3.2 m (10'6")**

**2.65 m (8'8")**

**3.75 m (12'4")**

### Bucket Type and Capacity

**1.54 m<sup>3</sup> (2.01 yd<sup>3</sup>)**

**1.71 m<sup>3</sup> (2.30 yd<sup>3</sup>)**

**1.3 m<sup>3</sup> (1.74 yd<sup>3</sup>)**

	3.2 m (10'6")		2.65 m (8'8")		3.75 m (12'4")	
	1.54 m <sup>3</sup> (2.01 yd <sup>3</sup> )		1.71 m <sup>3</sup> (2.30 yd <sup>3</sup> )		1.3 m <sup>3</sup> (1.74 yd <sup>3</sup> )	
<b>1</b> Maximum Digging Depth	6990 mm	22'11"	6440 mm	21'2"	7540 mm	24'9"
<b>2</b> Maximum Reach at Ground Level	10 640 mm	34'11"	10 160 mm	33'4"	11 140 mm	36'7"
<b>3</b> Maximum Cutting Height	11 150 mm	36'7"	10 950 mm	35'11"	11 410 mm	37'5"
<b>4</b> Maximum Loading Height	7970 mm	26'2"	7750 mm	25'5"	8240 mm	27'0"
<b>5</b> Minimum Loading Height	2920 mm	9'7"	3480 mm	11'5"	2370 mm	7'0"
<b>6</b> Maximum Cut Depth	6830 mm	22'5"	6260 mm	20'6"	7400 mm	24'3"
<b>7</b> Maximum Depth Cut for 2440 mm (8 ft) Level Bottom	6830 mm	22'5"	6260 mm	20'6"	7400 mm	24'3"
<b>8</b> Maximum Vertical Wall Digging Depth	5770 mm	18'11"	5460 mm	17'11"	6210 mm	20'4"
Tip Bucket Digging Force (SAE)	158 kN	35,500 lbf	158 kN	35,500 lbf	158 kN	35,500 lbf
Cutting Edge Bucket Digging Force (ISO)	179 kN	40,200 lbf	179 kN	40,200 lbf	179 kN	40,200 lbf
Tip Stick Digging Force (SAE)	123 kN	27,700 lbf	140 kN	31,500 lbf	111 kN	25,000 lbf
Cutting Edge Stick Digging Force (ISO)	126 kN	28,300 lbf	145 kN	32,600 lbf	114 kN	25,600 lbf

# 335F L Hydraulic Excavator Specifications

## Operating Weights and Ground Pressures

	Track Shoe without Blade							
	600 mm (24 in) Triple Grouser L Shoes				850 mm (33 in) Triple Grouser L Shoes			
	Weight		Ground Pressure		Weight		Ground Pressure	
	kg	lb	kPa	psi	kg	lb	kPa	psi
<b>Reach Boom (6.15 m/20'2")</b>								
CB1350HD Bucket								
R3.2CB2 (3.2 m/10'6") Stick	34 580	76,240	64.4	9.3	35 880	79,100	47.2	6.8
R2.65CB2 (2.65 m/8'8") Stick	34 420	75,880	64.1	9.3	35 720	78,750	47.0	6.8
CB1233HD Bucket								
R3.75CB2 (3.75 m/12'4") Stick	34 740	76,590	64.7	9.4	36 040	79,450	47.4	6.9
	Track Shoe with Blade							
	600 mm (24 in) Triple Grouser L Shoes							
	Weight				Ground Pressure			
	kg	lb	kPa	psi	kg	lb	kPa	psi
<b>Reach Boom (6.15 m/20'2")</b>								
CB1350HD Bucket								
R3.2CB2 (3.2 m/10'6") Stick			36 720		80,950	68.4		9.9
R2.65CB2 (2.65 m/8'8") Stick			36 560		80,600	68.1		9.9
CB1233HD Bucket								
R3.75CB2 (3.75 m/12'4") Stick			36 880		81,310	68.7		10.0

Operating weight is based on ISO 6016: Machine (upper and lower structure), front structure, 100% full fuel tank, fluids at normal level (i.e.: oils/water/lubricants), bucket (currently = "WW Major Bucket") without fill materials, 75 kg (165 lb) operator.

Notes: No optional attachments are included, the bucket is empty.

The minimum and maximum operating weights currently shown in Specalogs are based on differences between front structures, tracks, and buckets.

The minimum and maximum operating weight does not consider optional attachments, nor factor different bucket sizes or couplers unless specified by GCI.

# 335F L Hydraulic Excavator Specifications

## Major Component Weights









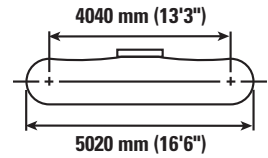
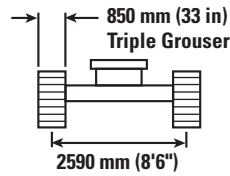
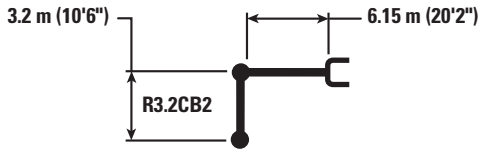





Base Machine – Includes: Boom Cylinders, Pins, Fluids	9350 kg	20,610 lb
Full Fuel Tank	320 kg	710 lb
Counterweight	7700 kg	16,980 lb
Boom (includes lines, pins, and stick cylinder)		
Reach Boom (6.15 m/20'2")	2230 kg	4,920 lb
Stick (includes lines, stick pins, bucket pins, and bucket cylinder)		
R3.2CB2	1180 kg	2,600 lb
R2.65CB2	1020 kg	2,240 lb
R3.75CB2	1340 kg	2,960 lb
Bucket Linkage		
CB2	290 kg	650 lb
Undercarriage		
Long Undercarriage	8230 kg	18,150 lb
Track Shoe		
600 mm (24 in) TG Shoe	4070 kg	8,960 lb
850 mm (33 in) TG Shoe	5370 kg	11,830 lb
Blade	2140 kg	4,720 lb
Common Buckets		
Bucket: CB1233HD 1.3 m <sup>3</sup> (1.74 yd <sup>3</sup> ) (331-1906)	1050 kg	2,310 lb
Bucket: CB1350HD 1.54 m <sup>3</sup> (2.01 yd <sup>3</sup> ) (331-1907)	1130 kg	2,490 lb
Bucket: CB1500GD 1.71 m <sup>3</sup> (2.30 yd <sup>3</sup> ) (346-0831)	1040 kg	2,300 lb
Quick Couplers		
Quick Coupler: Pin Grabber Type CB without Pin (349-7473)	500 kg	1,110 lb
Quick Coupler: Pin Grabber Type CB with Pin (356-8109)	530 kg	1,170 lb



# 335F L Hydraulic Excavator Specifications

## Reach Boom Lift Capacities – Counterweight: 7.7 mt (16,976 lb) – without Bucket



		1.5 m/5.0 ft		3.0 m/10.0 ft		4.5 m/15.0 ft		6.0 m/20.0 ft		7.5 m/25.0 ft		9.0 m/30.0 ft				m ft
																
9.0 m	kg							*6350	*6350					*6200	*6200	6.04
30.0 ft	lb													*13,800	*13,800	19.17
7.5 m	kg							*8100	*8100					*5550	*5550	7.44
25.0 ft	lb							*17,800	*17,800					*12,300	*12,300	24.17
6.0 m	kg							*8600	*8600	*8050	6050			*5350	5100	8.33
20.0 ft	lb							*18,700	*18,550	*17,350	13,050			*11,750	11,300	27.50
4.5 m	kg			*17 050	*17 050	*11 850	*11 850	*9650	8300	*8500	5950			*5350	4550	8.89
15.0 ft	lb			*36,150	*36,150	*25,500	*25,500	*20,950	17,900	*18,550	12,750			*11,750	10,000	29.17
3.0 m	kg					*14 700	12 000	*11 000	7900	*9150	5750	*6750	4350	*5500	4250	9.16
10.0 ft	lb					*31,700	25,900	*23,800	17,050	*19,900	12,350	*12,250	9,400	*12,100	9,350	30.00
1.5 m	kg					*16 750	11 350	*12 150	7550	9350	5550	7150	4300	*5850	4150	9.18
5.0 ft	lb					*36,200	24,450	*26,250	16,300	20,150	11,950	*13,600	9,200	*12,900	9,150	30.83
0.0 m	kg			*6050	*6050	*17 300	11 050	*12 700	7350	9200	5400			*6500	4250	8.95
0.0 ft	lb			*13,900	*13,900	*37,500	23,750	*27,500	15,800	19,800	11,650			*14,300	9,400	30.00
-1.5 m	kg	*7550	*7550	*11 450	*11 450	*16 650	10 950	*12 500	7250	9150	5350			*7550	4600	8.44
-5.0 ft	lb	*16,800	*16,800	*25,900	*25,900	*36,050	23,600	*27,000	15,600	19,700	11,550			*16,700	10,150	28.33
-3.0 m	kg			*18 300	*18 300	*14 850	11 050	*11 300	7300	*8400	5450			*8200	5350	7.60
-10.0 ft	lb			*41,500	*41,500	*32,150	23,800	*24,400	15,700					*18,000	11,850	25.00
-4.5 m	kg			*15 050	*15 050	*11 550	11 300	*8400	7500					*7650	7050	6.30
-15.0 ft	lb			*32,200	*32,200	*24,650	24,350	*17,450	16,200					*16,750	15,800	20.83



ISO 10567



\*Indicates that the load is limited by hydraulic lifting capacity rather than tipping load. The above loads are in compliance with hydraulic excavator lift capacity standard ISO 10567:2007. They do not exceed 87% of hydraulic lifting capacity or 75% of tipping load. Weight of all lifting accessories must be deducted from the above lifting capacities. Lifting capacities are based on the machine standing on a firm, uniform supporting surface. The use of a work tool attachment point to handle/lift objects, could affect the machine lift performance.









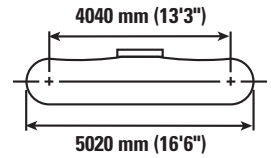
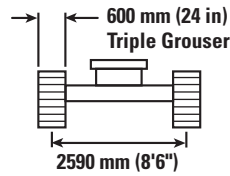
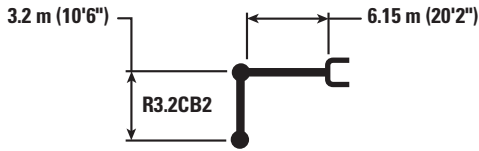





Lift capacity stays with ±5% for all available track shoes.

Always refer to the appropriate Operation and Maintenance Manual for specific product information.

# 335F L Hydraulic Excavator Specifications

## Reach Boom Lift Capacities – Counterweight: 7.7 mt (16,976 lb) – without Bucket



		1.5 m/5.0 ft		3.0 m/10.0 ft		4.5 m/15.0 ft		6.0 m/20.0 ft		7.5 m/25.0 ft		9.0 m/30.0 ft				m ft
																
9.0 m	kg							*6350	*6350					*6200	*6200	6.04
30.0 ft	lb													*13,800	*13,800	19.17
7.5 m	kg							*8100	*8100					*5550	*5550	7.44
25.0 ft	lb							*17,800	*17,800					*12,300	*12,300	24.17
6.0 m	kg							*8600	8300	*8050	5850			*5350	4900	8.33
20.0 ft	lb							*18,700	17,900	*17,350	12,550			*11,750	10,900	27.50
4.5 m	kg			*17 050	*17 050	*11 850	*11 850	*9650	8000	*8500	5700			*5350	4350	8.89
15.0 ft	lb			*36,150	*36,150	*25,500	*25,500	*20,950	17,250	*18,550	12,250			*11,750	9,600	29.17
3.0 m	kg					*14 700	11 600	*11 000	7600	*9150	5500	*6750	4200	*5500	4100	9.16
10.0 ft	lb					*31,700	24,950	*23,800	16,400	19,800	11,850	*12,250	9,000	*12,100	9,000	30.00
1.5 m	kg					*16 750	10 900	*12 150	7250	9000	5350	6900	4100	*5850	4000	9.18
5.0 ft	lb					*36,200	23,500	*26,250	15,650	19,350	11,450	*13,600	8,850	*12,900	8,800	30.83
0.0 m	kg			*6050	*6050	*17 300	10 600	12 350	7050	8850	5200			*6500	4100	8.95
0.0 ft	lb			*13,900	*13,900	*37,500	22,800	26,600	15,150	19,050	11,150			*14,300	9,000	30.00
-1.5 m	kg	*7550	*7550	*11 450	*11 450	*16 650	10 550	12 250	6950	8800	5150			7450	4400	8.44
-5.0 ft	lb	*16,800	*16,800	*25,900	*25,900	*36,050	22,650	26,350	14,950	18,900	11,050			16,450	9,750	28.33
-3.0 m	kg			*18 300	*18 300	*14 850	10 600	*11 300	7000	*8400	5200			*8200	5150	7.60
-10.0 ft	lb			*41,500	*41,500	*32,150	22,850	*24,400	15,050					*18,000	11,350	25.00
-4.5 m	kg			*15 050	*15 050	*11 550	10 900	*8400	7200					*7650	6750	6.30
-15.0 ft	lb			*32,200	*32,200	*24,650	23,450	*17,450	15,550					*16,750	15,200	20.83



ISO 10567



\*Indicates that the load is limited by hydraulic lifting capacity rather than tipping load. The above loads are in compliance with hydraulic excavator lift capacity standard ISO 10567:2007. They do not exceed 87% of hydraulic lifting capacity or 75% of tipping load. Weight of all lifting accessories must be deducted from the above lifting capacities. Lifting capacities are based on the machine standing on a firm, uniform supporting surface. The use of a work tool attachment point to handle/lift objects, could affect the machine lift performance.









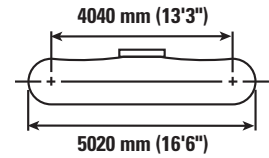
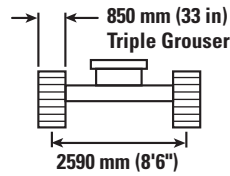
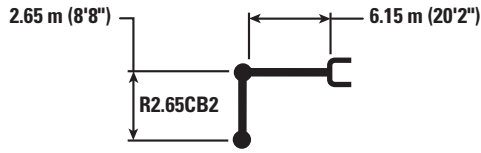

Lift capacity stays with ±5% for all available track shoes.

Always refer to the appropriate Operation and Maintenance Manual for specific product information.

# 335F L Hydraulic Excavator Specifications

## Reach Boom Lift Capacities – Counterweight: 7.7 mt (16,976 lb) – without Bucket



		3.0 m/10.0 ft		4.5 m/15.0 ft		6.0 m/20.0 ft		7.5 m/25.0 ft				
												m ft
9.0 m 30.0 ft	kg lb									*8300 *18,600	*8300 *18,600	5.29 16.67
7.5 m 25.0 ft	kg lb					*9000 *19,750	8700 18,600			*7250 *16,100	7000 15,750	6.85 22.50
6.0 m 20.0 ft	kg lb					*9350 *20,400	8550 18,400	*8750 *17,650	6050 12,950	*6900 *15,200	5650 12,550	7.81 25.83
4.5 m 15.0 ft	kg lb			*13 100 *28,150	12 700 27,350	*10 400 *22,500	8250 17,750	*9050 *19,700	5950 12,750	*6850 *15,050	5000 11,000	8.40 27.50
3.0 m 10.0 ft	kg lb			*15 850 *34,050	11 900 25,600	*11 650 *25,150	7900 17,000	9600 20,600	5750 12,400	*7050 *15,500	4650 10,250	8.69 29.17
1.5 m 5.0 ft	kg lb			*16 050 *37,550	11 350 24,450	*12 600 *27,250	7600 16,400	9400 20,250	5600 12,050	*7500 *16,500	4550 10,050	8.71 29.17
0.0 m 0.0 ft	kg lb			*17 300 *37,550	11 150 24,000	*12 900 27,850	7450 16,000	9300 20,000	5500 11,850	7850 17,300	4700 10,350	8.46 28.33
-1.5 m -5.0 ft	kg lb	*11 500 *26,200	*11 500 *26,200	*16 200 *35,150	11 150 24,000	*12 350 *26,700	7400 15,900	9300 20,000	5500 11,850	8600 19,000	5150 11,300	7.92 26.67
-3.0 m -10.0 ft	kg lb	*17 800 *38,650	*17 800 *38,650	*13 950 *30,200	11 300 24,300	*10 700 *22,950	7450 16,100			*8450 *18,550	6100 13,500	7.02 23.33
-4.5 m -15.0 ft	kg lb			*9850 *20,700	*9850 *20,700					*7350 *15,950	*7350 *15,950	5.58 18.33



ISO 10567



\*Indicates that the load is limited by hydraulic lifting capacity rather than tipping load. The above loads are in compliance with hydraulic excavator lift capacity standard ISO 10567:2007. They do not exceed 87% of hydraulic lifting capacity or 75% of tipping load. Weight of all lifting accessories must be deducted from the above lifting capacities. Lifting capacities are based on the machine standing on a firm, uniform supporting surface. The use of a work tool attachment point to handle/lift objects, could affect the machine lift performance.









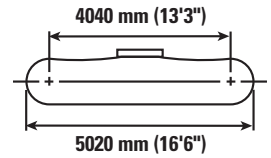
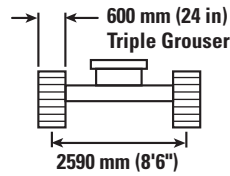
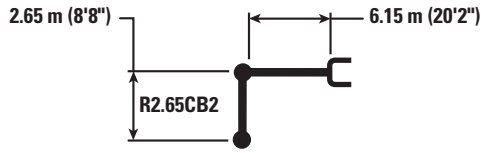

Lift capacity stays with  $\pm 5\%$  for all available track shoes.

Always refer to the appropriate Operation and Maintenance Manual for specific product information.

# 335F L Hydraulic Excavator Specifications

## Reach Boom Lift Capacities – Counterweight: 7.7 mt (16,976 lb) – without Bucket



		3.0 m/10.0 ft		4.5 m/15.0 ft		6.0 m/20.0 ft		7.5 m/25.0 ft				
												m ft
9.0 m 30.0 ft	kg lb									*8300 <b>*18,600</b>	*8300 <b>*18,600</b>	5.29 <b>16.67</b>
7.5 m 25.0 ft	kg lb					*9000 <b>*19,750</b>	8400 <b>18,000</b>			*7250 <b>*16,100</b>	6750 <b>15,200</b>	6.85 <b>22.50</b>
6.0 m 20.0 ft	kg lb					*9350 <b>*20,400</b>	8250 <b>17,750</b>	*8750 <b>*17,650</b>	5800 <b>12,450</b>	*6900 <b>*15,200</b>	5450 <b>12,050</b>	7.81 <b>25.83</b>
4.5 m 15.0 ft	kg lb			*13 100 <b>*28,150</b>	12 250 <b>26,450</b>	*10 400 <b>*22,500</b>	7950 <b>17,150</b>	*9050 <b>*19,700</b>	5700 <b>12,250</b>	*6850 <b>*15,050</b>	4800 <b>10,550</b>	8.40 <b>27.50</b>
3.0 m 10.0 ft	kg lb			*15 850 <b>*34,050</b>	11 450 <b>24,700</b>	*11 650 <b>*25,150</b>	7600 <b>16,400</b>	9250 <b>19,850</b>	5550 <b>11,900</b>	*7050 <b>*15,500</b>	4450 <b>9,850</b>	8.69 <b>29.17</b>
1.5 m 5.0 ft	kg lb			*16 050 <b>*37,550</b>	10 900 <b>23,500</b>	*12 600 <b>*27,200</b>	7300 <b>15,750</b>	9050 <b>19,500</b>	5400 <b>11,600</b>	7300 <b>16,050</b>	4400 <b>9,650</b>	8.71 <b>29.17</b>
0.0 m 0.0 ft	kg lb			*17 300 <b>*37,550</b>	10 750 <b>23,050</b>	12 450 <b>26,800</b>	7150 <b>15,350</b>	8950 <b>19,250</b>	5300 <b>11,400</b>	7550 <b>16,600</b>	4500 <b>9,900</b>	8.46 <b>28.33</b>
-1.5 m -5.0 ft	kg lb	*11 500 <b>*26,200</b>	*11 500 <b>*26,200</b>	*16 200 <b>*35,150</b>	10 750 <b>23,050</b>	*12 350 <b>26,650</b>	7100 <b>15,250</b>	8950 <b>19,200</b>	5250 <b>11,350</b>	8300 <b>18,300</b>	4950 <b>10,850</b>	7.92 <b>26.67</b>
-3.0 m -10.0 ft	kg lb	*17 800 <b>*38,650</b>	*17 800 <b>*38,650</b>	*13 950 <b>*30,200</b>	10 850 <b>23,350</b>	*10 700 <b>*22,950</b>	7150 <b>15,450</b>			*8450 <b>*18,550</b>	5850 <b>13,000</b>	7.02 <b>23.33</b>
-4.5 m -15.0 ft	kg lb			*9850 <b>*20,700</b>	*9850 <b>*20,700</b>					*7350 <b>*15,950</b>	*7350 <b>*15,950</b>	5.58 <b>18.33</b>



ISO 10567



\*Indicates that the load is limited by hydraulic lifting capacity rather than tipping load. The above loads are in compliance with hydraulic excavator lift capacity standard ISO 10567:2007. They do not exceed 87% of hydraulic lifting capacity or 75% of tipping load. Weight of all lifting accessories must be deducted from the above lifting capacities. Lifting capacities are based on the machine standing on a firm, uniform supporting surface. The use of a work tool attachment point to handle/lift objects, could affect the machine lift performance.

Lift capacity stays with ±5% for all available track shoes.

Always refer to the appropriate Operation and Maintenance Manual for specific product information.

# 335F L Hydraulic Excavator Specifications

## 335F L (with or without blade) Work Tool Offering Guide\*

Boom Option	Reach Boom		
	R3.75 (12'4")	R3.2 (10'6")	R2.65 (8'8")
Stick Option			
Hammer	H120Es H130Es H140Es B35	H120Es H130Es H140Es B35	H120Es H130Es H140Es B35
Multi-Processor	MP324 CC Jaw** MP324 D Jaw** MP324 P Jaw*** MP324 U Jaw*** MP324 S Jaw** MP324 TS Jaw***	MP324 CC Jaw MP324 D Jaw MP324 P Jaw** MP324 U Jaw MP324 S Jaw MP324 TS Jaw**	MP324 CC Jaw MP324 D Jaw MP324 P Jaw MP324 U Jaw MP324 S Jaw MP324 TS Jaw
Mobile Scrap and Demolition Shear	S320B  S340B#	S320B S325B** S340B#	S320B S325B** S340#
Pulverizer	P225**	P225	P225
Demolition and Sorting Grapple (D-Demolition, R-Recycling Shells)	G320B-D/R** G325B-D***	G320B-D/R G325B-D**	G320B-D/R G325B-D
Compactor (Vibratory Plate)	CVP110	CVP110	CVP110
Orange Peel Grapple			
Clamshells			
Thumbs			
Rippers			
Rakes			
Pin Grabber Coupler			
Dedicated Quick Coupler			

These work tools are available for the 335F L.  
Consult your Cat dealer for proper match.

\*Offerings not available in all areas. Matches are dependent on excavator configurations. Consult your Cat dealer to determine what is offered in your area and for proper work tool match.

\*\*Pin-on or Dedicated coupler.

\*\*\*Pin-on only.

#Boom mount.

# 335F L Hydraulic Excavator Specifications

## Bucket Specifications and Compatibility – ANZ

	Linkage	Width		Capacity		Weight		Fill %	With Blade 600 mm (24 in) TG			Without Blade 600 mm (24 in) TG			
		mm	in	m <sup>3</sup>	yd <sup>3</sup>	kg	lb		Reach Boom			Reach Boom			
									R2.65 (8'8")	R3.2 (10'6")	R3.75 (12'4")	R2.65 (8'8")	R3.2 (10'6")	R3.75 (12'4")	
<b>With Pin Grabber Coupler</b>															
General Duty (GD)	CB	600	24	0.52	0.68	659	1,451	100%	●	●	●	●	●	●	
	CB	750	30	0.71	0.93	726	1,599	100%	●	●	●	●	●	●	
	CB	1000	40	1.03	1.35	834	1,838	100%	●	●	●	●	●	●	
	CB	1350	54	1.54	2.02	1004	2,212	100%	●	⊙	⊖	●	⊙	⊖	
	CB	1500	60	1.76	2.30	1068	2,353	100%	⊙	⊙	⊖	⊙	⊖	○	
	CB	1600	63	1.86	2.43	1098	2,419	100%	⊙	⊖	○	⊖	○	○	
Heavy Duty (HD)	CB	600	24	0.52	0.68	808	1,780	100%	●	●	●	●	●	●	
	CB	750	30	0.71	0.93	947	2,086	100%	●	●	●	●	●	●	
	CB	900	36	0.91	1.19	1040	2,292	100%	●	●	●	●	●	●	
	CB	1050	42	1.12	1.46	1134	2,498	100%	●	●	●	●	●	●	
	CB	1200	48	1.33	1.74	1206	2,657	100%	●	●	●	●	●	⊙	
	CB	1350	54	1.54	2.02	1305	2,876	100%	●	●	⊙	●	⊙	⊖	
	CB	1500	60	1.76	2.30	1406	3,098	100%	●	⊙	⊖	⊙	⊖	○	
	CB	1650	66	1.97	2.58	1477	3,254	100%	⊙	⊖	○	⊖	○	○	
Severe Duty (SD)	CB	1050	42	1.12	1.46	1241	2,734	90%	●	●	●	●	●	●	
Maximum load pin-on (payload + bucket)									kg	4570	4078	3587	4154	3689	3223
									lb	10,073	8,989	7,907	9,156	8,132	7,105

### Maximum Material Density:

- 2100 kg/m<sup>3</sup> (3,500 lb/yd<sup>3</sup>)
- ⊙ 1800 kg/m<sup>3</sup> (3,000 lb/yd<sup>3</sup>)
- ⊖ 1500 kg/m<sup>3</sup> (2,500 lb/yd<sup>3</sup>)
- 1200 kg/m<sup>3</sup> (2,000 lb/yd<sup>3</sup>)

The above loads are in compliance with hydraulic excavator standard EN474, they do not exceed 87% of hydraulic lifting capacity or 75% of tipping capacity with front linkage fully extended at ground line with bucket curled.

Capacity based on ISO 7451.

Bucket weight with General Duty tips.

Caterpillar recommends using appropriate work tools to maximize the value customers receive from our products. Use of work tools, including buckets, which are outside of Caterpillar's recommendations or specifications for weight, dimensions, flows, pressures, etc. may result in less-than-optimal performance, including but not limited to reductions in production, stability, reliability, and component durability. Improper use of a work tool resulting in sweeping, prying, twisting and/or catching of heavy loads will reduce the life of the boom and stick.

# 335F L Hydraulic Excavator Specifications

## Bucket Specifications and Compatibility – NACD

	Linkage	Width		Capacity		Weight		Fill	With Blade			Without Blade			
									850 mm (33 in) TG			850 mm (33 in) TG			
		Reach Boom			Reach Boom			Reach Boom			Reach Boom				
		mm	in	m <sup>3</sup>	yd <sup>3</sup>	kg	lb	%	R2.65 (8'8")	R3.2 (10'6")	R3.75 (12'4")	R2.65 (8'8")	R3.2 (10'6")	R3.75 (12'4")	
<b>Without Quick Coupler</b>															
General Duty (GDC)	CB	600	24	0.63	0.83	724	1,595	100%	●	●	●	●	●	●	
	CB	750	30	0.86	1.13	810	1,785	100%	●	●	●	●	●	●	
	CB	900	36	1.09	1.43	907	1,998	100%	●	●	●	●	●	●	
	CB	1050	42	1.34	1.75	979	2,157	100%	●	●	●	●	●	●	
	CB	1200	48	1.58	2.07	1070	2,358	100%	●	●	●	●	●	⊙	
Heavy Duty (HD)	CB	1350	54	1.83	2.40	1164	2,564	100%	●	⊙	⊖	●	⊙	⊖	
	CB	600	24	0.52	0.68	763	1,681	100%	●	●	●	●	●	●	
	CB	750	30	0.71	0.93	847	1,866	100%	●	●	●	●	●	●	
	CB	900	36	0.91	1.19	935	2,061	100%	●	●	●	●	●	●	
	CB	1050	42	1.12	1.46	1024	2,256	100%	●	●	●	●	●	●	
	CB	1200	48	1.33	1.74	1095	2,413	100%	●	●	●	●	●	●	
	CB	1350	54	1.54	2.02	1188	2,618	100%	●	●	●	●	●	⊙	
Severe Duty (SD)	CB	1500	60	1.76	2.30	1285	2,831	100%	●	⊙	⊖	●	⊙	⊖	
	CB	1650	66	1.97	2.58	1357	2,990	100%	●	⊙	⊖	⊙	⊖	○	
	CB	600	24	0.52	0.68	810	1,784	90%	●	●	●	●	●	●	
	CB	750	30	0.71	0.93	902	1,987	90%	●	●	●	●	●	●	
	CB	900	36	0.91	1.19	999	2,202	90%	●	●	●	●	●	●	
	CB	1050	42	1.12	1.46	1097	2,417	90%	●	●	●	●	●	●	
	CB	1200	48	1.33	1.74	1178	2,595	90%	●	●	●	●	●	●	
Maximum load pin-on (payload + bucket)									kg	5287	4782	4278	4872	4393	3914
									lb	11,653	10,540	9,429	10,738	9,682	8,626
<b>With Pin Grabber Coupler</b>															
General Duty (GDC)	CB	600	24	0.63	0.83	724	1,595	100%	●	●	●	●	●	●	
	CB	750	30	0.86	1.13	810	1,785	100%	●	●	●	●	●	●	
	CB	900	36	1.09	1.43	907	1,998	100%	●	●	●	●	●	●	
	CB	1050	42	1.34	1.75	979	2,157	100%	●	●	●	●	●	⊙	
	CB	1200	48	1.58	2.07	1070	2,358	100%	●	●	⊙	●	⊙	⊖	
Heavy Duty (HD)	CB	1350	54	1.83	2.40	1164	2,564	100%	⊙	⊖	⊖	⊙	⊖	○	
	CB	600	24	0.52	0.68	763	1,681	100%	●	●	●	●	●	●	
	CB	750	30	0.71	0.93	847	1,866	100%	●	●	●	●	●	●	
	CB	900	36	0.91	1.19	935	2,061	100%	●	●	●	●	●	●	
	CB	1050	42	1.12	1.46	1024	2,256	100%	●	●	●	●	●	●	
	CB	1200	48	1.33	1.74	1095	2,413	100%	●	●	●	●	●	⊙	
	CB	1350	54	1.54	2.02	1188	2,618	100%	●	●	⊖	●	⊙	⊖	
Severe Duty (SD)	CB	1500	60	1.76	2.30	1285	2,831	100%	⊙	⊖	○	⊙	⊖	○	
	CB	1650	66	1.97	2.58	1357	2,990	100%	⊙	⊖	○	⊖	○	◇	
	CB	600	24	0.52	0.68	810	1,784	90%	●	●	●	●	●	●	
	CB	750	30	0.71	0.93	902	1,987	90%	●	●	●	●	●	●	
	CB	900	36	0.91	1.19	999	2,202	90%	●	●	●	●	●	●	
	CB	1050	42	1.12	1.46	1097	2,417	90%	●	●	●	●	●	●	
	CB	1200	48	1.33	1.74	1178	2,595	90%	●	●	●	●	●	⊙	
Maximum load pin-on (payload + bucket)									kg	4782	4277	3773	4367	3888	3409
									lb	10,541	9,428	8,317	9,626	8,570	7,514

### Maximum Material Density:

- 2100 kg/m<sup>3</sup> (3,500 lb/yd<sup>3</sup>)
- ⊙ 1800 kg/m<sup>3</sup> (3,000 lb/yd<sup>3</sup>)
- ⊖ 1500 kg/m<sup>3</sup> (2,500 lb/yd<sup>3</sup>)
- 1200 kg/m<sup>3</sup> (2,000 lb/yd<sup>3</sup>)
- ◇ 900 kg/m<sup>3</sup> (1,500 lb/yd<sup>3</sup>)

The above loads are in compliance with hydraulic excavator standard EN474, they do not exceed 87% of hydraulic lifting capacity or 75% of tipping capacity with front linkage fully extended at ground line with bucket curled.

Capacity based on ISO 7451.

Bucket weight with General Duty tips.

Caterpillar recommends using appropriate work tools to maximize the value customers receive from our products. Use of work tools, including buckets, which are outside of Caterpillar's recommendations or specifications for weight, dimensions, flows, pressures, etc. may result in less-than-optimal performance, including but not limited to reductions in production, stability, reliability, and component durability. Improper use of a work tool resulting in sweeping, prying, twisting and/or catching of heavy loads will reduce the life of the boom and stick.

# 335F L Standard Equipment

## Standard Equipment

Standard equipment may vary. Consult your Cat dealer for details.

### ENGINE

- Cat C7.1 ACERT diesel engine
  - Biodiesel capable up to B20
  - Meets Tier 4 Final/Stage IV emission standards
  - Standard, economy, and high power modes
- Automatic engine speed control
- Automatic engine idle shutdown
- Three-stage fuel filtration system with water separator and indicator
- 4600 m (15,000 ft) altitude capability
- 52° C (126° F) high ambient cooling capability
- 115 amp alternator
- Radial seal air filter with double filter element
- Electric fuel priming pump

### HYDRAULIC SYSTEM

- Electric boom regeneration circuit
- Stick regeneration circuit
- One-touch lifting mode
- Automatic two-speed travel
- Boom and stick drift reduction valve
- Reverse swing damping valve
- High-performance hydraulic return filter

### CAB

- Openable skylight as emergency exit
- Openable laminated front upper windshield with assist device
- Removable tempered lower windshield with in-cab storage bracket
- Fully adjustable seat, console and armrest
- 51 mm (2 in) width seat belt
- Full graphic 178 mm (7 inch) LCD monitor, with distortion-free rearview camera picture
- Automatic bi-level air conditioner with pressurized function
- 12V × 2 power supply with sockets
- Washable floor mat
- Flexible seat belt

### UNDERCARRIAGE & STRUCTURES

- HD track rollers
- Grease lubricated track link
- Tie down points on base frame
- HD bottom guard

### ELECTRICAL

- Maintenance-free battery
- Centralized electrical disconnect switch
- Programmable time delay working lights

### SERVICE & MAINTENANCE

- Grouped oil, fuel, and hydraulic oil filters for ease of maintenance
- Sampling ports for Scheduled Oil Sampling (S·O·S<sup>SM</sup>)
- Air-to-air aftercooler (ATAAC) and fixed-type A/C condenser

### SAFETY & SECURITY

- Rearview camera with three mirrors
- Hand rail mirror for right rear view
- Bolt-free service platform with anti-skid plate
- Neutral lever for all controls
- Ground-level-accessible secondary engine shutoff switch in cab
- Signaling/warning horn
- Safety hammer for cab evacuation
- Travel alarm

### CAT CONNECT TECHNOLOGY

- Product Link
- Rearview camera



## Optional Equipment

Optional equipment may vary. Consult your Cat dealer for details.

### CAB

- 24V AM/FM radio with AUX input
- High back seat with air suspension, seat heater and head rest
- High back seat with air suspension, seat heater/cooler and head rest
- Control pattern quick-changer: two way

### FRONT LINKAGE

- CB2 bucket linkage without lifting eye
- R2.65CB2 (8'8") stick
- R3.2CB2 (10'6") stick
- R3.75CB2 (12'4") stick

### HYDRAULICS

- Boom and stick lines
- High-pressure lines
- Tool control system
- Quick coupler arrangement
- Medium pressure lines
- Two-way control pattern changer

### SECURITY

- Track guiding guards
- Swivel guard

### UNDERCARRIAGE

- 600 mm (24 in) triple grouser shoes
- 850 mm (33 in) triple grouser shoes

### MISCELLANEOUS

- Cold weather lubricants
- Air cleaner with pre-cleaner
- Dozer blade (3200 mm/10'6")
- Boom and stick lowering check valves

### OPTIONAL EQUIPMENT – DEALER INSTALLED KITS AND ATTACHMENTS

- Electrical
  - Cold weather field installation retrofit kit package
- Cab
  - Rain protector for front windshield
  - Seat belt, retractable (76 mm/3 in width)
  - Ashtray for cup holder
- Guards
  - FOGS retrofit kit package
  - Mesh for front guard retrofit kit package
  - Mesh guard, lower half front
  - Mesh for front guard retrofit package
  - Vandalism guard with holder
- Safety & Security
  - Security system (MSS)
  - Travel alarm (factory installed)





For more complete information on Cat products, dealer services, and industry solutions, visit us on the web at [www.cat.com](http://www.cat.com)

AEHQ7862  
(ADSD-N/ANZ)

© 2017 Caterpillar  
All rights reserved

Materials and specifications are subject to change without notice. Featured machines in photos may include additional equipment. See your Cat dealer for available options.

CAT, CATERPILLAR, SAFETY.CAT.COM, their respective logos, "Caterpillar Yellow" and the "Power Edge" trade dress, as well as corporate and product identity used herein, are trademarks of Caterpillar and may not be used without permission.

VisionLink is a trademark of Trimble Navigation Limited, registered in the United States and in other countries.

