



# D8T DOZER

COVERING AW4, MB8, JJ5, J8B, KPZ, MLN, FCT, FMC

## PARTS REFERENCE GUIDE

**LET'S DO THE WORK.™**



# PROTECT YOUR INVESTMENT WITH GENUINE CAT® PARTS

Thank you for selecting the Cat® D8T Dozer.

This guide is designed to provide you with a quick reference for the parts and part numbers you need to keep your Cat D8T Dozer running at peak efficiency.



## MAINTENANCE

Proactive preventative maintenance extends the life of your machine and protects your investment. Only Caterpillar knows Cat equipment's filtration and lubrication requirements and offers parts kits to match your machine's maintenance cycles.



SCHEDULED MAINTENANCE PARTS	
	GREASES
	PLANNED MAINTENANCE KITS

## REPLACEMENT PARTS

Proper maintenance minimizes the need for repair and replacement. In the event that replacement parts are required, the use of genuine Cat parts helps maximize machine performance and maintains high resale value.

REPAIR PARTS	
	MAJOR COMPONENTS
	UNDER CARRIAGE
	GENERAL PARTS
WEAR PARTS	
	PINS AND BEARINGS
	GROUND ENGAGING TOOLS

## GREASES D8T

Previous Cat Product Name	STANDARD MAINTENANCE GREASES			GREASES FOR UNIQUE APPLICATIONS AND ENVIRONMENTS	
	Cat Ultra 5 Moly	Cat Ultra 5 Moly	Cat Advanced 3 Moly	Cat Desert Gold	Cat Multipurpose
Current Cat Product Name	Cat Extreme Application Grease 1	Cat Extreme Application Grease 2	Cat Prime Application Grease	Cat Extreme Application Grease – Desert	Cat Utility Grease
Grade (NLGI)	1	2	2	2	2
Melting point (deg C)	>260	>260	260	280	260
Ambient Temperature (deg C)	-35 to +40	-30 to +50	-20 to +40	-30 to +50	-30 to +40
Base Oil Type	Mineral	Mineral	Mineral	Mineral	Mineral
Cartridge (390 g / 14 oz)	452-5996	452-6001	452-6006	452-6016	452-6011
Plastic Pail (16 kg / 35 lb)	452-5999	452-6004	452-6009	452-6019	452-6014
Keg (55 kg / 120 lb)	452-5998	452-6003	452-6008	452-6018	452-6013
					

Our greases are designed to get the longest life, unmatched moisture resistance, lowest component wear and best corrosion protection for your application.

## COOLANTS D8T

CAT ELC® PREMIX LOWERS MAINTENANCE COSTS AND ENSURES EXTENDED LIFE COOLANT			CAT ELC® EXTENDER ENSURES EXTENDED LIFE COOLANT PERFORMANCE		COOLING CONDITIONER FOR ALUMINUM COMPONENTS
5 liters	20 liters	210 liters	0.9 liter	3.8 liters	74 ml
205-6611	205-6612	205-6613	119-5152	210-0786	369-0805
					

Up to 12,000-hour (or 6-year) drain interval with an addition of Cat Extender at 6,000-hours and yearly S•O•S<sup>SM</sup> coolant sampling analysis.

# PLANNED MAINTENANCE KITS D8T

DOZER		A		B												
		Scheduled Oil Sample	Multipurpose Grease	Fuel Tank		Engine Oil Filter		Transmission Oil Filter			Hydraulic Oil Filter			Fuel/Water Separator	Oil	
Sales Model	Prefix	SOS	Gallons 0.3 - Liters 1.0	Filler Cap Filter Kit	Seal-O-Ring	Filter Element Assembly	Diesel Engine Oil (ECF - 3/API)	S/N J8B 1-1425 Filter Element	S/N J8B 1914-UP Filter Assembly	Filter Element	Seal-o-Ring (Case Drain Cover Seal)	Filter (Case Drain)	Seal-O-Ring	Filter	Filter	
D8T	MLN	(16) SOS	-			(3) 1R-1808	(36) DEO-ULS			(3) 337-5270		(3) 1R-0777		(3) 326-1643		
	FCT	(16) SOS	-	(3) 350-07735	(3) 7D-7111	(3) 1R-1808	(36) DEO-ULS			(3) 337-5270	(3) 5H-6733	(3) 1R-0777	(3) 2H-6124	(3) 326-1643		
	FMC	(16) SOS	(4) GREASE	(3) 350-07735		(3) 1R-1808	(33) DEO-ULS							(3) 326-1643		
	J8B	(16) SOS	(5) 452-6006	(3) 9x-2205	(3) 9X-8600	(3) 1R-0716	(136.26) DEO-ULS	(3) 132-8876	(6) 328-3655		(3) 5H-6733	(3) 1R-0777	(3) 2H-6124	(3) 326-1644	(3) 465-6502	
	KPZ	(16) SOS	(5) 452-6006	(3) 9x-2205	(3) 9X-8600		(136.26) DEO-ULS	(3) 132-8876	(6) 328-3655						(3) 465-6502	
	MB8	-					1R-0716 (STD) 1R-1808 (HE)									
	JJ5	-					1R-0716 (STD) 1R-1808 (HE)									
	AW4	-					500-0483									

DOZER		B							C			D						
		Engine Valve Mechanism	Steering Charge Oil Filter	Power Train	Trans/Drive Train Oil	Level 2 Coolant	Fuel Filter		Power Train		Winch Oil & Breather	Hydraulic Oil Filter	Final Drive Guard Packing	Air	Hydraulic Oil	Air Conditioning Receiver	Grease	
Sales Model	Prefix	Seal	Filter	Filter	Gallons 4.0 - Liters 15.0		Secondary Fuel Filter	Filter Assembly	Oil	Breather	15 Liters 4 Gal	Filter	Seal (Packing)	Filter Element Assembly	Filter	Dryer	Grease Artic	
D8T	MLN							(6) 1R-0749				(2) 465-6506	(4) 137-9810				(2) 129-1928	
	FCT							(6) 1R-0749				(2) 465-6506	(4) 137-9810				(2) 129-1928	
	FMC				(105) TDTO	SOS COOL-2		(6) 1R-0749				(2) 465-6506	(4) 137-9810					
	J8B	(6) 242-9537	(3) 1G-8878		(382.32) TDTO	(2) SOS COOL-2							(4) 137-9810	(2) 6I-2506 (2) 6I-2505	126-1813	3E-3535	(2) 129-1928	
	KPZ	(6) 242-9537			(382.32) TDTO	(2) SOS COOL-2								(2) 6I-2506 (2) 6I-2505	126-1813	3E-3535		
	MB8		225-4118	337-5270				(2) 1R-0749	326-1643 423-8525 (Bowl-less)	155 Liters 41 Gal	9G-5127	126-3220					106-5534	
	JJ5		225-4118	337-5270				(2) 1R-0749	326-1643 423-8525 (Bowl-less)	155 Liters 41 Gal	9G-5127	126-3220					106-5534	
	AW4							(2) 500-0480	436-7077	337-5270	9G-5127							

# PLANNED MAINTENANCE KITS D8T

DOZER		E	F							G	AS NEEDED							
		Engine Valve Mechanism Cover	Air Conditioning	Seat Belt	Coolant Extender	Water Temperature Regulator				Extended Life Coolant	Cooling System Refill	Lubrication	Engine Air Filter		Cab Air Filter		Radiator	
Sales Model	Prefix	Seal	Receiver Dryer Assembly	Seat Belt	Coolant Extender	Regulator	Seal	Seal	Hydro Advance 10	Extended Life Coolant	Bearing	Cartridge Grease	Primary Filter Element	Secondary Filter Element	Recirculation	Recirculation	Cap Assembly	
D8T	MLN		(3) 320-0562	(3) 272-2272	(4) 119-5152	(4) 248-5513			(40) Hydro 10	(21) Coolant		(3) 452-6006	396-2122	331-8111	346-8243	231-0167		
	FCT	(6) 242-9537	(3) 320-0562	(3) 272-2272	(4) 119-5152	(4) 248-5513	(2) 341-1429	(4) 3S-9643	(40) Hydro 10			(3) 452-6006	396-2122	331-8111	346-8243	231-0167	294-3342	
	FMC	(9) 242-9537		(3) 381-4538	(2) 119-5152	(4) 248-5513	(2) 341-1429	(4) 3S-9643		(76.80) Coolant (ELC)		452-6006	420-5282	331-8111		231-0167		
	J8B			(3) 222-0345	(7.57) 119-5152	(4) 248-5513	(2) 341-1429	(4) 3S-9643		(302.83) Coolant	(80) 5M-0578				209-8217	238-0479		
	KPZ			(3) 222-0345	(7.57) 119-5152	(4) 248-5513				(302.83) Coolant	(80) 5M-0578				209-8217	238-0479		
	MB8													6I-2505	6I-2506	112-7448 (STD) 175-2838 (HE)	396-7087	294-3342
	JJ5													6I-2505	6I-2506	112-7448 (STD) 175-2838 (HE)	396-7087	294-3342
	AW4													420-5282	331-8111	231-0167 (Prim) 326-7963 (UHE)	396-7087	294-3342

PARTS MAINTENANCE KITS							
250	A						
500	A	B					
750	A						
1000	A	B	C				
1250	A						
1500	A	B					
1750	A						
2000	A	B	C	D			
2250	A						
2500	A	B			E		
2750	A						
3000	A	B	C				
3250	A						

PARTS MAINTENANCE KITS							
3500	A	B					
3750	A						
4000	A	B	C	D			
4250	A						
4500	A	B					
4750	A						
5000	A	B	C		E		
5250	A						
5500	A	B					
5750	A						
6000	A	B	C	D		F	
10000	A	B	C	D	E		
12000	A	B	C	D		F	G

**LINKAGE PIN PART NUMBERS**

Sales Model	Prefix	Ripper - Fixed Parallelogram					
		AA	BB	CC	DD	EE	FF
<b>D8T</b>	AW4	(2) 4T-1389 Pin Assembly	(2) 6J-9482 Pin Assembly	(2) 162-0390 Pin	(2) 1U-0990 Pin	(2) 1U-0990 Pin	(2) 132-7994 Pin Assembly
		(2) 4T-1389 Pin Assembly	(2) 4T-1389 Pin Assembly				(2) 4T-0203 Pin Assembly
	MB8, JJ5	(2) 4T-1389 Pin Assembly	(2) 6J-9482 Pin Assembly	(2) 162-0390 Pin	(2) 1U-0990 Pin	(2) 1U-0990 Pin	(2) 132-7994 Pin Assembly
	J8B, KPZ	(2) 4T-1389 Pin Assembly	(2) 6J-9482 Pin Assembly	(2) 162-0390 Pin	(2) 1U-0990 Pin	(2) 1U-0990 Pin	(2) 132-7994 Pin Assembly
			2) 4T-1389 Pin Assembly				(2) 4T-0203 Pin Assembly
	MLN, FCT	(2) 4T-1389 Pin Assembly	(2) 6J-9482 Pin Assembly	(2) 162-0390 Pin	(2) 1U-0990 Pin	(2) 1U-0990 Pin	(2) 132-7994 Pin Assembly
			(2) 4T-1389 Pin Assembly				2) 4T-0203 Pin Assembly
	FMC	(2) 4T-1389 Pin Assembly	(2) 6J-9482 Pin Assembly	(2) 162-0390 Pin	(2) 1U-0990 Pin	(2) 1U-0990 Pin	(2) 132-7994 Pin Assembly
			(2) 4T-1389 Pin Assembly				(2) 4T-0203 Pin Assembly

**BEARING & BUSHING PART NUMBERS**

Sales Model	Prefix	Ripper - Fixed Parallelogram					
		AA	BB	CC	DD	EE	FF
<b>D8T</b>	AW4	(4) 7T-3746 Bushing	(4) 4T-9751 Bushing	(2) 3G-5999 Bushing	(2) 3G-5999 Bushing	(2) 3G-5999 Bushing	(2) 3G-5999 Bushing
			(4) 7T-3746 Bushing				
	MB8, JJ5	(4) 7T-3746 Bushing	(4) 4T-9751 Bushing	(2) 3G-5999 Bushing	(2) 3G-5999 Bushing	(2) 3G-5999 Bushing	(2) 3G-5999 Bushing
	J8B, KPZ	(4) 7T-3746 Bushing	(4) 4T-9751 Bushing	(2) 3G-5999 Bushing	(2) 3G-5999 Bushing	(2) 3G-5999 Bushing	(2) 3G-5999 Bushing
			(4) 7T-3746 Bushing				
	MLN, FCT	(4) 7T-3746 Bushing	(4) 4T-9751 Bushing	(2) 3G-5999 Bushing	(2) 3G-5999 Bushing	(2) 3G-5999 Bushing	(2) 3G-5999 Bushing
			(4) 7T-3746 Bushing				
	FMC	(4) 7T-3746 Bushing	(4) 4T-9751 Bushing	(2) 3G-5999 Bushing	(2) 3G-5999 Bushing	(2) 3G-5999 Bushing	(2) 3G-5999 Bushing
			(4) 7T-3746 Bushing				



# DOZER - STRAIGHT/SEMI UNIVERSE

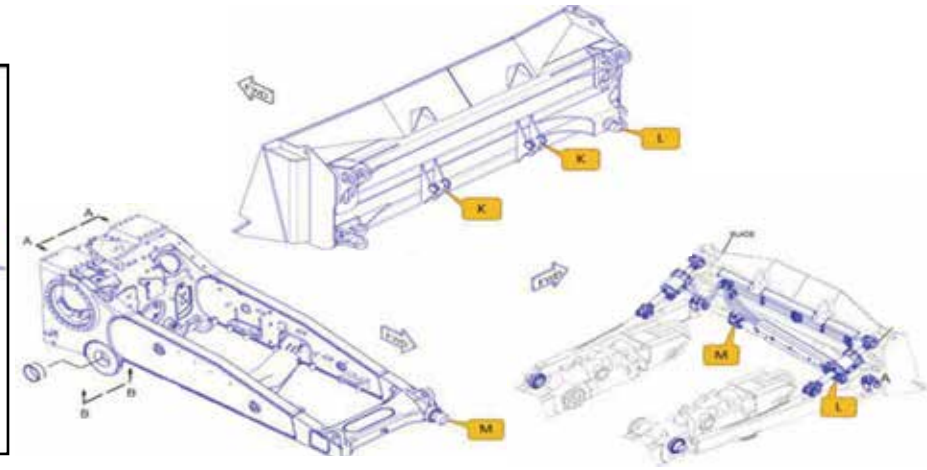
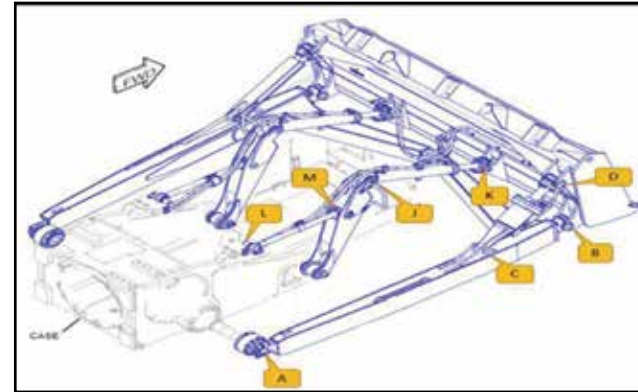
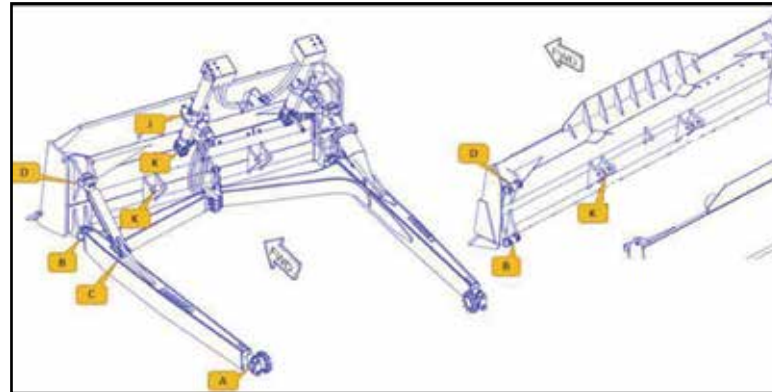
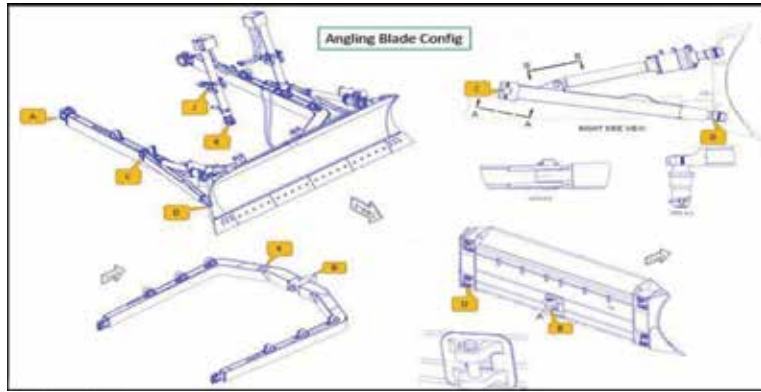

## LINKAGE PIN PART NUMBERS

Sales Model	Prefix	Blade - L Shaped							
		A	B	C	D	J	K	L	M
D8T	AW4	(2) 524-4892 Trunnion	(4) 4T-7534 Pin	3G-7016 Pin (RH) 239-9940 Pin (LH)	(2) 1U-2472 Pin	238-8637 Cylinder Assembly	(2) 9J-0123 Trunnion	110-2966 Trunnion	110-3292 Trunnion
	MB8, JJ5	(2) 524-4892 Trunnion	(4) 4T-7534 Pin	3G-7016 Pin (RH) 239-9940 Pin (LH)	(2) 1U-2472 Pin	238-8637 Cylinder Assembly	(2) 9J-0123 Trunnion	110-2966 Trunnion	110-3292 Trunnion
	J8B, KPZ	(2) 524-4892 Trunnion	(4) 4T-7534 Pin	3G-7016 Pin (RH) 239-9940 Pin (LH)	(2) 1U-2472 Pin	238-8637 Cylinder Assembly	(2) 9J-0123 Trunnion	110-2966 Trunnion	110-3292 Trunnion
				(2) 3G-7016 Pin					
	MLN, FCT	(2) 524-4892 Trunnion	(4) 4T-7534 Pin	3G-7016 Pin (RH) 239-9940 Pin (LH)	(2) 1U-2472 Pin	238-8637 Cylinder Assembly	(2) 9J-0123 Trunnion	110-2966 Trunnion	110-3292 Trunnion
				(2) 3G-7016 Pin					
	FMC	(2) 524-4892 Trunnion	(4) 4T-7534 Pin	3G-7016 Pin (RH) 239-9940 Pin (LH)	(2) 1U-2472 Pin	238-8637 Cylinder Assembly	(2) 9J-0123 Trunnion	110-2966 Trunnion	110-3292 Trunnion
				(2) 3G-7016 Pin					

## BEARING & BUSHING PART NUMBERS

Sales Model	Prefix	Blade - L Shaped								
		A	B	C	D	J	K	L	M	
D8T	AW4	(2) 193-3063 Cap Bearing (2) 1J-6740 Bearing	8x 8E-6752 Bushing (4) 3G-9598 Bushing	(2) 1U-2182 Bushing (RH)	(2) 7J-3297 Bearing	(4) 6E-1108 Bushing (4) 104-1844 Bushing	(2) 160-6310 Cap Bearing	160-6307 Cap Bearing 6I-8676 Bearing	160-6307 Cap Bearing 6I-8676 Bearing	
				(4) 1U-2182 Bushing						
	MB8, JJ5	(2) 193-3063 Cap Bearing (2) 1J-6740 Bearing	8x 8E-6752 Bushing (4) 3G-9598 Bushing	8x 8E-6752 Bushing (4) 3G-9598 Bushing	(2) 1U-2182 Bushing (RH)	(2) 7J-3297 Bearing	(4) 6E-1108 Bushing (4) 104-1844 Bushing	(2) 160-6310 Cap Bearing	160-6307 Cap Bearing 6I-8676 Bearing	160-6307 Cap Bearing 6I-8676 Bearing
					(4) 1U-2182 Bushing					
	J8B, KPZ	(2) 193-3063 Cap Bearing (2) 1J-6740 Bearing	8x 8E-6752 Bushing (4) 3G-9598 Bushing	8x 8E-6752 Bushing (4) 3G-9598 Bushing	(2) 1U-2182 Bushing (RH)	(2) 7J-3297 Bearing	(4) 6E-1108 Bushing (4) 104-1844 Bushing	(2) 160-6310 Cap Bearing	160-6307 Cap Bearing 6I-8676 Bearing	160-6307 Cap Bearing 6I-8676 Bearing
					(4) 1U-2182 Bushing					
	MLN, FCT	(2) 193-3063 Cap Bearing (2) 1J-6740 Bearing	8x 8E-6752 Bushing (4) 3G-9598 Bushing	8x 8E-6752 Bushing (4) 3G-9598 Bushing	(2) 1U-2182 Bushing (RH)	(2) 7J-3297 Bearing	(4) 6E-1108 Bushing (4) 104-1844 Bushing	(2) 160-6310 Cap Bearing	160-6307 Cap Bearing 6I-8676 Bearing	160-6307 Cap Bearing 6I-8676 Bearing
					(4) 1U-2182 Bushing					
	FMC	(2) 193-3063 Cap Bearing (2) 1J-6740 Bearing	8x 8E-6752 Bushing (4) 3G-9598 Bushing	8x 8E-6752 Bushing (4) 3G-9598 Bushing	(2) 1U-2182 Bushing (RH)	(2) 7J-3297 Bearing	(4) 6E-1108 Bushing (4) 104-1844 Bushing	(2) 160-6310 Cap Bearing	160-6307 Cap Bearing 6I-8676 Bearing	160-6307 Cap Bearing 6I-8676 Bearing
					(4) 1U-2182 Bushing					

# DOZER - VPAT/ANGLING

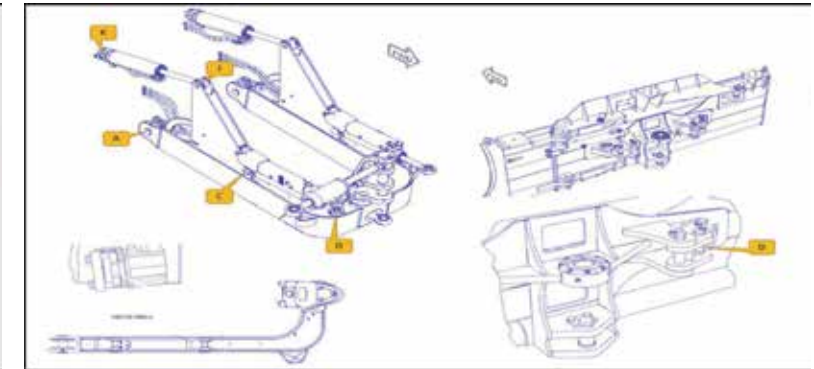
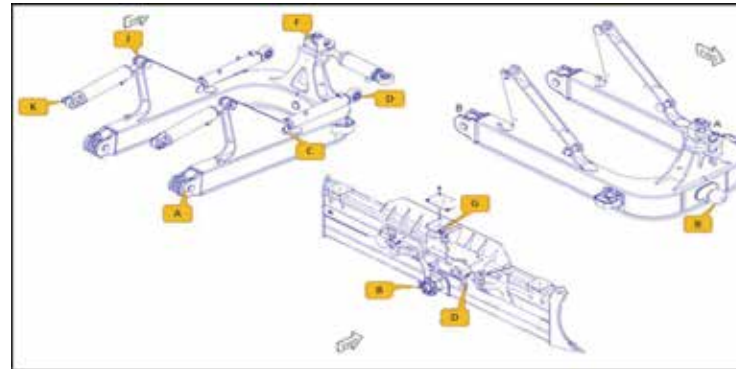
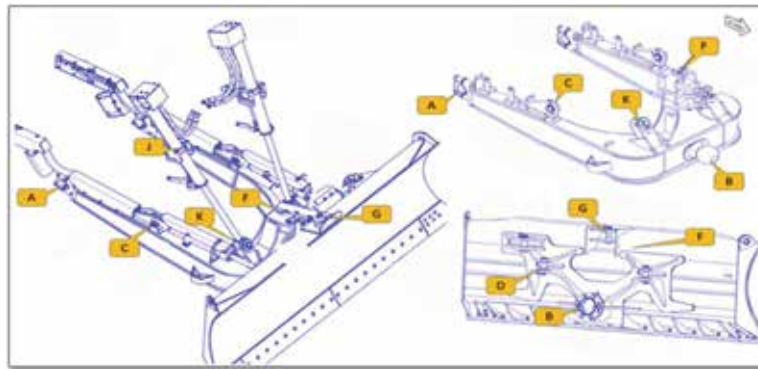
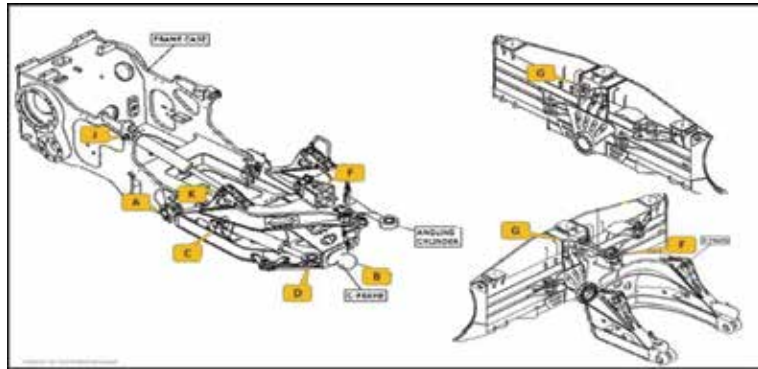

## LINKAGE PIN PART NUMBERS

Sales Model	Prefix	VPAT Vertical Lift Cylinders								Equalizer Bar	
		A	B	C	D	F	G	J	K	A (Ebar Center)	B (Ebar Outer)
<b>D8T</b>	AW4	(2) 524-4892 Trunnion Assembly	159-8807 Pin	(2) 158-3653 Pin	(2) 6J-3774 Pin	(2) 3G-7016 Pin	(2) 163-5778 Trunnion	238-8637 Cylinder Assembly	(2) 9J-0123 Trunnion	219-5743 Pin	(2) 219-5735 Pin
	MB8, JJ5	(2) 524-4892 Trunnion Assembly	—	—	—	—	—	—	—	219-5743 Pin	(2) 219-5735 Pin
	J8B, KPZ	(2) 524-4892 Trunnion Assembly	159-8807 Pin	(2) 158-3653 Pin	(2) 6J-3774 Pin	(2) 3G-7016 Pin	(2) 163-5778 Trunnion	238-8637 Cylinder Assembly	(2) 9J-0123 Trunnion	219-5743 Pin	(2) 219-5735 Pin
	MLN, FCT	(2) 524-4892 Trunnion Assembly	159-8807 Pin	(2) 158-3653 Pin	2) 6J-3774 Pin	(2) 3G-7016 Pin	(2) 163-5778 Trunnion	238-8637 Cylinder Assembly	(2) 9J-0123 Trunnion	219-5743 Pin	(2) 219-5735 Pin
	FMC	(2) 524-4892 Trunnion Assembly	159-8807 Pin	(2) 158-3653 Pin	2) 6J-3774 Pin	(2) 3G-7016 Pin	(2) 163-5778 Trunnion	238-8637 Cylinder Assembly	(2) 9J-0123 Trunnion	219-5743 Pin	(2) 219-5735 Pin







## BEARING & BUSHING PART NUMBERS

Sales Model	Prefix	VPAT Vertical Lift Cylinders								Equalizer Bar	
		A	B	C	D	F	G	J	K	A (Ebar Center)	B (Ebar Outer)
<b>D8T</b>	AW4	(2) 193-3063 Cap Assembly Bearing (2) 1J-6744 Bearing	—	(2) 3J-5190 Cap Bearing (2) 156-4127 Bearing	(2) 7T-9147 Bearing	(4) 1U-2182 Bushing	(2) 160-6309 Cap Bearing	(4) 6E-1108 Bushing (4) 104-1844 Bushing	(2) 160-6310 Cap Bearing	(2) 524-1338 Bushing	(2) 117-4013 Bushing
	MB8, JJ5	—	—	—	—	—	—	—	(2) 130-3139 Bushing	(2) 117-4013 Bushing	
	J8B, KPZ	(2) 193-3063 Cap Assembly Bearing (2) 1J-6744 Bearing	—	(2) 3J-5190 Cap Bearing (2) 156-4127 Bearing	(2) 7T-9147 Bearing	(4) 1U-2182 Bushing	(2) 160-6309 Cap Bearing	(4) 6E-1108 Bushing (4) 104-1844 Bushing	(2) 160-6310 Cap Bearing	(2) 130-3139 Bushing	(2) 117-4013 Bushing
	MLN, FCT	(2) 193-3063 Cap Assembly Bearing (2) 1J-6744 Bearing	—	(2) 3J-5190 Cap Bearing (2) 156-4127 Bearing	(2) 7T-9147 Bearing	(4) 1U-2182 Bushing	(2) 160-6309 Cap Bearing	(4) 6E-1108 Bushing (4) 104-1844 Bushing	(2) 160-6310 Cap Bearing	(2) 130-3139 Bushing	(2) 117-4013 Bushing
	FMC	(2) 193-3063 Cap Assembly Bearing (2) 1J-6744 Bearing	—	(2) 3J-5190 Cap Bearing (2) 156-4127 Bearing	(2) 7T-9147 Bearing	(4) 1U-2182 Bushing	(2) 160-6309 Cap Bearing	(4) 6E-1108 Bushing (4) 104-1844 Bushing	(2) 160-6310 Cap Bearing	(2) 130-3139 Bushing	(2) 117-4013 Bushing

# D8 Angle-Blades

Blade Serial Numbers: BHR, 9ZP, DZD, D1E, D1F, DK4

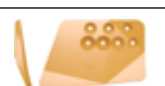





Applies to: D8R, D8T, D8

End Bits and Cutting Edges 13"											
Type		End Bits				Edges				Notes	
		Thickness	End Bits	Hardware	Position	Thickness	Edges	Quantity	Hardware		
	Level Cut	28	6Y-4277 6Y-4278	7 7	RH LH	28	135-9373	3	8	GP: 507-2918	
	Utility	50	100-3139 100-3140	7 7	RH LH	45	135-9629	3	8	GP: 507-2919	
		60	136-8757 136-8756	7 7	RH LH						
	HC	35	3G-8291 3G-8292	7 7	RH LH	28	135-9373	3	8	GP: 507-2920	
		40	3G-8283 3G-8284	7 7	RH LH	35	135-9628	3	8	GP: 507-2921	
	GD	30	8E-4193 8E-4194	7 7	RH LH	28	135-9373	3	8	Equipped from factory GP: 135-9374	
	EWL	35	8E-4537 8E-4538	7 7	RH LH	35	135-9628	3	8	GP: 507-2922	
Specialty											
	Utility A.R.M.	50	379-3173 379-3174	7 7	RH LH						
	GD A.R.M.	35	377-5059 377-5060 455-3704 455-3705	7 7	RH LH RH LH						
Hardware, Repair Parts and Wear Protection											
Type	Description	Part Number	Quantity	Notes							
Hardware	Bolts	1-8 x 3	4F-4042	38	Ensure Base Edge is flat and not excessively worn Clean and remove any paint on mating surfaces Torque, Bang, Torque						
	Nuts	1-8	2J-3507	38							
	Washers	1"	5P-8250	38							
Blade Repair	Edge Support	147-3527	1								

# D8 LGP Angle-Blades

Blade Serial Numbers: 7HW

Applies to: D8T, D8











End Bits and Cutting Edges 13"											
Type		End Bits				Edges				Notes	
		Thickness	End Bits	Hardware	Position	Thickness	Edges	Quantity	Hardware		
	Level Cut	28	6Y-4277 6Y-4278	7 7	RH LH	28	456-2889	3	9	GP: 565-2195	
	Utility	50	100-3139 100-3140	7 7	RH LH	45	456-7775	3	9	GP: 565-2196	
		60	136-8757 136-8756	7 7	RH LH						
	HC	35	3G-8291 3G-8292	7 7	RH LH	28	456-2889	3	9	GP: 565-2197	
		40	3G-8283 3G-8284	7 7	RH LH	35	456-7774	3	9	GP: 565-2198	
	GD	30	8E-4193 8E-4194	7 7	RH LH	28	456-2889	3	9	Equipped from factory GP: 456-8297	
	EWL	35	8E-4537 8E-4538	7 7	RH LH	35	456-7774	3	9	GP: 565-2199	
Specialty											
	Utility A.R.M.	50	379-3173 379-3174	7 7	RH LH						
	GD A.R.M.	35	377-5059 377-5060 455-3704 455-3705	7 7 7 7	RH LH RH LH						
Hardware, Repair Parts and Wear Protection											
Type	Description	Part Number	Quantity	Notes							
Hardware	Bolts	1-8 x 3	4F-4042	38	Ensure Base Edge is flat and not excessively worn Clean and remove any paint on mating surfaces Torque, Bang, Torque						
	Nuts	1-8	2J-3507	38							
	Washers	1"	5P-8250	38							
Blade Repair	Edge Support	147-3527	1								

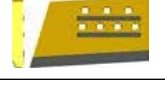

# D8 LGP Semi U-Blades

Blade Serial Numbers: KMB, LAA, DZC, DK5











Applies to: D8R, D8T, D8

End Bits and Cutting Edges 13"												
Type		End Bits				Edges					Notes	
		Thickness	End Bits	Hardware	Position	Thickness	Edges	Quantity	Position	Hardware		
	Level Cut	28	6Y-4277 6Y-4278	7 7	RH LH	28	6Y-5540 4Z-9058	2 1	E C	5 13		
	Utility	50	100-3139 100-3140	7 7	RH LH							
		60	136-8757 136-8756	7 7	RH LH							
	HC	35	3G-8291 3G-8292	7 7	RH LH	28	6Y-5540 4Z-9058	2 1	E C	5 13	GP: 507-2926	
		40	3G-8283 3G-8284	7 7	RH LH							
	GD	30	8E-4193 8E-4194	7 7	RH LH	28	6Y-5540 4Z-9058	2 2	E C	5 13	Equipped from factory GP: 7T-5559	
	Performance	35	479-8129 479-8130	7 7	RH LH	35	479-8131 479-8132 522-3986	1 1 1	RH LH C	5 5 13	GP: 497-8143	
	EWL	35	8E-4537 8E-4538	7 7	RH LH							
Specialty												
	Utility A.R.M.	50	379-3173 379-3174	7 7								
	GD A.R.M.	35	377-5059 377-5060	7 7	RH LH							
			455-3704 455-3705	7 7	RH LH							
Hardware, Repair Parts and Wear Protection												
Type	Description	Part Number	Quantity	Notes								
Hardware	Bolts	1-8 x 3-1/4	4J-9058	36	Ensure Base Edge is flat and not excessively worn Clean and remove any paint on mating surfaces Torque, Bang, Torque							
	Nuts	1-8	2J-3507	36								
	Washers	1"	5P-8250	36								
Blade Repair	Edge Support	239-4172 256-4890	2 1									
Sidebar Protector	Protector	9J-9600	2	ref PELM1017 D8 and D9 Bulldozer Sidebar Protector ref PELJ1389 Shear Blocks for Sidebar Protectors								
	Shear Block		331-7417									2
	Adapter Plate		152-0027									2
	Retainer		8E-6359									4
	Pin		135-9350									4
Wear Protection	Wear Bars	25x203x4572	107-3391	2	Provides 2 wear bar coverage full width of blade							
		16mm	9W-2756 9W-2757 9W-2758 9W-2759 9W-2760	1 1 1 1 1	5 piece set							
	Push Plate	16mm	9W-2756	1								

# D8 Performance Semi U-Blades

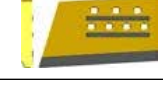
Blade Serial Numbers: SN4, P32











Applies to: D8T, D8

End Bits and Cutting Edges 13"												
Type		End Bits				Edges					Notes	
		Thickness	End Bits	Hardware	Position	Thickness	Edges	Quantity	Position	Hardware		
	Level Cut	28	6Y-4277 6Y-4278	7 7	RH LH	28	6Y-5540 460-4973	2 1	E C	5 9	GP: 565-2190	
	Utility	50	100-3139 100-3140	7 7	RH LH	45	112-2471 474-7182	2 1	E C	5 9	GP: 565-2191	
		60	136-8757 136-8756	7 7	RH LH							
	HC	35	3G-8291 3G-8292	7 7	RH LH	28	6Y-5540 460-4973	2 1	E C	5 9	GP: 565-2192	
		40	3G-8283 3G-8284	7 7	RH LH	35	7T-9125 474-7181	2 1	E C	5 9	GP: 565-2193	
	GD	30	8E-4193 8E-4194	7 7	RH LH	28	6Y-5540 460-4973	2 1	E C	5 9	Equipped from factory GP: 461-2342	
	Performance	35	479-8129 479-8130	7 7	RH LH	35	479-8131 479-8132 474-7181	1 1 1	RH LH C	5 5 9	GP: 517-5504	
	EWL	35	8E-4537 8E-4538	7 7	RH LH	35	7T-9125 474-7181	2 1	E C	5 9	GP: 497-8346	
Specialty												
	Utility A.R.M.	50	379-3173 379-3174	7 7	RH LH							
	GD A.R.M.	35	377-5059 377-5060	7 7	RH LH							
			455-3704 455-3705	7 7	RH LH							
Hardware, Repair Parts and Wear Protection												
Type	Description	Part Number	Quantity	Notes								
Hardware	Bolts	1-8 x 3-1/4	4J-9058	36	Ensure Base Edge is flat and not excessively worn Clean and remove any paint on mating surfaces Torque, Bang, Torque							
	Nuts	1-8	2J-3507	36								
	Washers	1"	5P-8250	36								
Blade Repair	Edge Support	239-4172 256-4890	2 1									
Sidebar Protector	Protector	9J-9600	2	ref PELM1017 D8 and D9 Bulldozer Sidebar Protector ref PELJ1389 Shear Blocks for Sidebar Protectors								
	Shear Block		331-7417									2
	Adapter Plate		152-0027									2
	Retainer		8E-6359									4
	Pin		135-9350									4
Wear Protection	Wear Bars	25x203x3658	107-3391	2	Provides 2 wear bar coverage full width of blade							
	Wear Plates	16mm	9W-2757 9W-2760 9W-1771	1 1 1	3 piece set							
			9W-2756 9W-2757 9W-2758 9W-2759 9W-2760	1 1 1 1 1	5 piece set							
			Push Plate	16mm	9W-2756	1						

# D8 Semi U-Blades

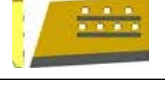
Blade Serial Numbers: 1KH, 2PP, 3MP, 3WH, 1HP, 6LH, 9BH, 9PH, 2NP, 05A, 9TP, BHW, B8S, DZA, DZX, DK2









Applies to: D8R, D8T, D8

End Bits and Cutting Edges 13"												
Type	End Bits				Edges					Notes		
	Thickness	End Bits	Hardware	Position	Thickness	Edges	Quantity	Position	Hardware			
	Level Cut	28	6Y-4277 6Y-4278	7 7	RH LH	28	6Y-5540 4T-6381	2 1	E C	5 9	GP: 507-2837	
	Utility	50	100-3139 100-3140	7 7	RH LH	45	112-2471 112-2472	2 1	E C	5 9	GP: 507-2838	
		60	136-8757 136-8756	7 7	RH LH							
	HC	35	3G-8291 3G-8292	7 7	RH LH	28	6Y-5540 4T-6381	2 1	E C	5 9	GP: 507-2839	
		40	3G-8283 3G-8284	7 7	RH LH	35	7T-9125 7T-9126	2 1	E C	5 9	GP: 507-2840	
	GD	30	8E-4193 8E-4194	7 7	RH LH	28	6Y-5540 4T-6381	2 1	E C	5 9	Equipped from factory GP: 7T-5558	
	Performance	35	479-8129 479-8130	7 7	RH LH	35	479-8131 479-8132 7T-9126	1 1 1	RH LH C	5 5 9	GP: 497-8143	
	EWL	35	8E-4537 8E-4538	7 7	RH LH	35	7T-9125 7T-9126	2 1	E C	5 9	GP: 9W-9096	
Specialty												
	Utility A.R.M	50	379-3173 379-3174	7 7	RH LH							
	GD A.R.M	35	377-5059 377-5060	7 7	RH LH							
			455-3704 455-3705	7 7	RH LH							
	HD Mining		n/a			120 60	113-0343 113-0323	2 1	E C	9 14		
Hardware, Repair Parts and Wear Protection												
Type	Description	Part Number	Quantity	Notes								
Hardware	Bolts	1-8 x 3-1/4	4J-9058	33	Ensure Base Edge is flat and not excessively worn Clean and remove any paint on mating surfaces Torque, Bang, Torque							
	Nuts	1-8	2J-3507	33								
	Washers	1"	5P-8250	33								
Blade Repair	Edge Support		239-4172 239-4176	2 1								
Sidebar Protector	Protector		9J-9600	2	ref PELM1017 D8 and D9 Bulldozer Sidebar Protector ref PELJ1389 Shear Blocks for Sidebar Protectors							
	Shear Block		331-7417	2								
	Adapter Plate		152-0027	2								
	Retainer		8E-6359	4								
	Pin		135-9350	4								
Wear Protection	Wear Bars	25x203x4572	107-3389	2	Provides 2 wear bar coverage full width of blade							
	Wear Plates	14mm	9W-2757	1	3 piece set							
			9W-2760	1								
			9W-1771	1								
	Wear Plates	16mm	9W-2756	1	5 piece set							
			9W-2757	1								
9W-2758			1									
9W-2759 9W-2760			1 1									
Push Plate	16mm	9W-2756	1									

# D8 U-Blades

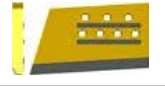
Blade Serial Numbers: 1JH, 2WP, 6AH, 9CH, 9WP, CXB, A5G, DZB, DK3

Applies to: D8R, D8T, D8

End Bits and Cutting Edges 13"												
Type	End Bits				Edges					Notes		
	Thickness	End Bits	Hardware	Position	Thickness	Edges	Quantity	Position	Hardware			
	Level Cut	28	6Y-4277 6Y-4278	7 7	RH LH	28	4T-6378 9W-5232	2 2	E C	6 5	GP: 507-2924	
	Utility	50	100-3139 100-3140	7 7	RH LH	45	112-2475 112-2473	2 2	E C	6 5	GP: 507-2925	
		60	136-8757 136-8756	7 7	RH LH							
	HC	35	3G-8291 3G-8292	7 7	RH LH	28	4T-6378 9W-5232	2 2	E C	6 5	GP: 507-2926	
		40	3G-8283 3G-8284	7 7	RH LH	35	9W-6092 7T-9127	2 2	E C	6 5	GP: 507-2927	
	GD	30	8E-4193 8E-4194	7 7	RH LH	28	4T-6378 9W-5232	2 2	E C	6 5	Equipped from factory GP: 7T-5559	
	EWL	35	8E-4537 8E-4538	7 7	RH LH	35	9W-6092 7T-9127	2 2	E C	6 5	GP: 9W-9097	
Specialty												
	Utility A.R.M	50	379-3173 379-3174	7 7	RH LH							
	GD A.R.M	35	377-5059 377-5060	7 7	RH LH							
			455-3704 455-3705	7 7	RH LH							
	HD Mining		n/a			120 60	113-0343 113-0323	2 1	E C	9 14		
Hardware, Repair Parts and Wear Protection												
Type	Description	Part Number	Quantity	Notes								
Hardware	Bolts	1-8 x 3-1/4	4J-9058	36	Ensure Base Edge is flat and not excessively worn Clean and remove any paint on mating surfaces Torque, Bang, Torque							
	Nuts	1-8	2J-3507	36								
	Washers	1"	5P-8250	36								
Blade Repair	Edge Support		255-8188 255-8189	2 1								
Sidebar Protector	Protector		9J-9600	2	ref PELM1017 D8 and D9 Bulldozer Sidebar Protector ref PELJ1389 Shear Blocks for Sidebar Protectors							
	Shear Block		331-7417	2								
	Adapter Plate		152-0027	2								
	Retainer		8E-6359	4								
	Pin		135-9350	4								
Wear Protection	Wear Bars	25x203x4572	107-3391	2	Provides 2 wear bar coverage full width of blade							
	Wear Plates	14mm	6Y-7244	1	3 piece set							
			6Y-7245	1								
			6Y-7246	1								
	Wear Plates	16mm	9T-0253	1	5 piece set							
			9T-0254	1								
4T-9592			1									
9T-0255 9T-0256			1 1									
Push Plate	16mm	4T-9592	1									

## RIPPER SHANKS

Machine Model	Shank Size	Type	Assembled Length	Part Number	Field Repair		Tip Size
					Adapter	Nose	
D8N, D8R, D8T	75mm x 332mm	(MS)	1610mm	8E-5346	8E-8418	9U-9694	R450 CR450
		(SS)	2010mm	8E-5347			
		(DR)	2459mm	8E-5340			

## RIPPER TIPS

Machine Model	Tip Size	Type	Style	Tips			Hardware		
				Short	Intermediate	Long	Pin	Qty	
D8N, D8R, D8T	R450 CR450	R450 Pin-on	Centerline	9W-2451	9W-2452	114-0453	Pin Retainer	6Y-3394 8E-4743	1 1
			A.R.M.		8E-5770				
			Penetration	4T-5451	4T-5452				
			A.R.M.		8E-5771				
			Sharp		416-0250				
		CR450 CapSure™	Centerline	380-1218	380-1209		Pin Kit	380-1211	1
			A.R.M.		380-1225				
			Penetration		380-1216				
			A.R.M.		380-1220				

## RIPPER SHANK PROTECTORS

Sales Model	Shank Width	Type	Standard	Sharp	Extended	Hardware		Quantity
D8N, D8R, D8T	75 mm	Pin-on	6J-8814	8E-1848	132-4716	Pin Retainer	6Y-3394 8E-4743	2 2
		CapSure™	–	380-1214	380-1223	Upper Lower	380-1211 380-1222	1 1



## MAJOR COMPONENTS

Item	Prefix	Standard	Reman
<b>Engine Remove &amp; Install</b>	MLN, FCT	RI-PARTS-4	20R-7041
Engine Recondition After Failure	MLN, FCT	364-4037	20R-7937
	FMC	415-5867	20R-0765
	J8B, KPZ	462-3178	
<b>Turbocharger Recondition After Failure</b>	MLN, FCT	450-0542	20R-9352
<b>Lift/Hoist Cylinder Recondition After Failure Each</b>	MLN, FCT, FMC, J8B, KPZ	250-5861	
<b>Lift/Hoist Cylinder Replace Gasket/Reseal Each</b>			
Seal A	MLN, FCT, FMC, J8B, KPZ	(2) 495-8197	
Seal		(10) 312-4247	
Seal Assembly		(10) 312-4248	
Seal -O-Ring		(2) 175-7902	
Ring-Wear		(2) 4J-3745	
Seal-U-Cup		(10) 421-4025	
Cost For Cylinder Hone		(12) Cylinder Hone	
<b>Lift/Hoist Cylinder Recondition Each</b>			
Rod Assembly	MLN, FCT, FMC, J8B, KPZ		0R-8922
Bearing-Sleeve		(2) 6E-1108	
Ring		8C-9161	
<b>Implement Pump Recondition After Failure</b>	MLN, FCT		(2) 10R-4714
<b>Implement Pump Rebearing &amp; Reseal</b>			
Bearing-Cradle	MLN, FCT, FMC	(2) 176-7507	
Bearing		290-0461	
Spring		191-7594	
Seal-O-Ring		(4) 5P-9186	
Cone-Roller Bearing		(3) 6Y-2736	
Cup-Roller Bearing		(3) 6Y-2736	
Seal-O-Ring		107-3114	
Spring		176-7512	
Seal-O-Ring		3D-2824	
Cone-Roller Bearing		1B-3908	
Cup-Roller Bearing		1B-3909	
Seal		(2) 203-1095	
Seal-O-Ring		204-3334	
Seal-O-Ring		(2) 3E-6761	
Seal-O-Ring		(2) 187-8567	
Spring		194-3288	
Spring		194-3289	
Seal-O-Ring		(2) 6V-5142	
Spring		191-7605	
Spring		194-3279	
Seal-O-Ring	MLN, FCT	(10) 033-6039	
Ring	FMC	6V-5200	
Ring		195-3325	
Kit-Valve Repair		191-7607	
Kit-Valve Repair		191-7608	
Ring		257-4385	
Gasket		(2) 445-2060	

MAJOR COMPONENTS			
Item	Prefix	Standard	Reman
<b>Hydraulic Fan Motor Recondition After Failure</b>	MLN, FCT, J8B, KPZ		(2) 10R-4581
<b>Hydraulic Fan Pump Recondition After Failure</b>			
Pump GP	MLN, FCT, FMC	(2) 325-9788	20R-7025
Pump GP		(2) 325-9788	20R-7026
Pump GP		J8B, KPZ	(2) 10R-6126
<b>Tilt Cylinder Recondition After Failure Each</b>	MLN, FCT, FMC, J8B, KPZ	6E-0397	
<b>Tilt Cylinder Replace Gasket/Reseal Each</b>			
Locknut	MLN, FCT, FMC, J8B, KPZ	(6) 2J-0564	
Seal A		(4) 5J-4993	
Seal-O-Ring		(2) 2K-2939	
Ring		(2) 2K-2940	
Ring-Wear		(3) 1J-2674	
Ring		(2) 9T-0094	
<b>Tilt Cylinder Recondition Each</b>			
Bearing	MLN, FCT, FMC, J8B, KPZ	(2) 1U-2182	
Rod Assembly - HYD			OR-8920
<b>Ripper Lift Cylinder Recondition After Each Failure</b>	MLN, FCT, FMC, J8B, KPZ	155-3653	
<b>Ripper Lift Cylinder Replace Gasket/Reseal Each</b>			
Seal-O-Ring	MLN, FCT, FMC, J8B, KPZ	(2) 5P-7593	
Ring-Backup		(2) 158-3027	
Seal		(2) 8T-8381	
<b>Ripper Lift Cylinder Recondition Each</b>			
Locknut	MLN, FCT, FMC, J8B, KPZ	2J-7686	
Bearing-Sleeve		(3) 3G-5999	
Rod Assembly			OR-3082
Ring		(4) 8T-1714	
<b>Ripper Pin PUL Cylinder Recondition After Failure</b>	MLN, FCT, FMC, J8B, KPZ	6E-3113	
<b>Ripper Pin PUL Cylinder Replace Gasket/Reseal</b>			
Ring-Wear	MLN, FCT, FMC, J8B, KPZ	(2) 6J-2797	
Seal Assembly		(2) 5J-5402	
Ring-Wear		(2) 4T-6907	
Seal-Wiper		(2) 308-1880	
Seal-U-Cup		(2) 439-2697	
Seal Assembly - Buffer		(2) 167-2190	
Rink-Backup		(2) 2K-6830	
Seal-O-Ring		(2) 175-7900	
<b>Ripper Pin PUL Cylinder Recondition - Rod Assembly</b>		MLN, FCT, FMC, J8B, KPZ	6E-3980
<b>Ripper Tilt Cylinder Recondition After Failure</b>	MLN, FCT, FMC, J8B, KPZ	165-0102	
		155-3652	
<b>Ripper Tilt Cylinder Replace Gasket/Reseal</b>			
Seal-O-Ring (24.99mm ID)	MLN, FCT, FMC	(4) 4J-5267	
Seal		(4) 8T-8379	
Ring-Backup		(4) 158-3026	
Seal		(4) 7J-8956	
Seal A		(4) 5J-4991	
Ring		(4) 3J-9703	
Kit-Hyd Cylinder Seal	J8B, KPZ	(4) 244-2050	

MAJOR COMPONENTS			
Item	Prefix	Standard	Reman
<b>Ripper Tilt Cylinder Recondition - Rod Assembly</b>	MLN, FCT, FMC, J8B, KPZ		OR-3080
<b>Ripper Tilt Cylinder Recondition - Ring</b>	J8B, KPZ	(2) 3J-9703	
<b>Steering Pump Recondition After Failure</b>	MLN, FCT		20R-7025
<b>Torque Converter Recondition After Failure</b>	FMC	374-8376	
	J8B, KPZ		(2) 10R-5294
<b>Alternator Recondition After Failure</b>			
Alternator GP-Charging	J8B, KPZ	249-0313	10R-9097B
Pulley AS-Idler		(2) 279-2589	
Guard AS-Alternator		292-4906	
Bracket AS		329-5071	
Nut-Weld		(2) 8T-3490	
Bolt		0S-0509	
Bolt		(2) 1608497	
Clip		4P-7581	
Washer		5M-2894	
Nut		6V-8188	
Bolt		7D-5962	
Bolt		7X-0339	
Bolt		8T-0638	
Washer		(5) 8T-4121	
Bolt		8T-4172	
Bolt		(4) 8T-4186	
Washer		(3) 8T-4223	
Washer	(3) 9X-8256		
<b>Carrier Roller Recondition After Failure Each</b>	J8B, KPZ		(2) 10R-2499
<b>Track Adjuster Recondition After Failure Each</b>			
Ring-Wear	J8B, KPZ	(2) 1M-1571	
Valve-Fill		190-8609	
Valve		2S-5926	
Cable AS		7T-4209	
Retainer		7T-4214	
Seal-U-Cup		8T-2185	
Retainer		9W-6074	
Piston		104-6374	
Spacer		154-3326	
Cylinder AS		154-3327	
Seal-O-Ring		(2) 6J-1038	
Ring-Retaining		8H-8830	
<b>Track Adjuster Recondition Each</b>			
Ring-Wear	J8B, KPZ	(2) 1M-1571	
Seal-U-Cup		8T-2185	
Retainer		9W-6074	
Seal-O-Ring		(2) 6J-1038	
Ring-Retaining		8H-8830	
<b>Idler/Idler Wheel Recondition After Failure Each</b>	J8B, KPZ	111-1730	

MAJOR COMPONENTS			
Item	Prefix	Standard	Reman
<b>Idler/Idler Wheel Recondition Each</b>			
Bearing-Sleeve	J8B, KPZ	(2) 154-3298	
Washer-Thrust		(2) 8E-6619	
Seal-O-Ring (67.94MM ID)		(2) 107-4057	
Seal GP-Duo-Cone		(2) 162-7863	
Seal-O-Ring		(2) 8F-9516	
Plug		(2) 6Y-0473	
Stopper-Rubber		9G-4872	
<b>Track Assembly Replace Each</b>		J8B, KPZ	8E-7696
<b>Track Assembly Turn/Reposition Each Section</b>			
Ring-Thrust	J8B, KPZ	(2) 360-2308	
Seal Assembly		(2) 239-7943	
Stopper		7G-4332	
<b>Track Show Remove &amp; Install Each</b>			
Bolt-Track	J8B, KPZ	(4) 6V-1723	
Nut-Track		(4) 7G-6442	
<b>Transmission Oil Pump Recondition After Failure</b>	J8B, KPZ	206-8703	20R-7455
<b>Transmission Oil Pump Recondition</b>			
Seal-O-Ring	J8B, KPZ	(4) 129-1609	
Key		1B-8714	
Key-Woodruff		2B-9373	
Locknut		2K-0337	
Seal-O-Ring		(3) 2955609	
<b>Sprocket Segment Replace Each</b>			
Segment	J8B, KPZ	278-2363	
Nut		(5) 7H-3608	
Bolt		(5) 5P-7665	
Washer-Hard		(5) 6V-5841	
<b>UPE / Air Filter Element(s) Replace With New</b>			
Cab Air Filter	J8B, KPZ	209-8217	
Filter		238-0479	
<b>Engine</b>	MB8, JJ5	456-6600 (Tier 2)	
		456-6602 (Tier 3)	
<b>Camshaft</b>		310-7612	20R-1135
<b>Connecting Rod</b>		224-3245	10R-2117
<b>Crankshaft</b>		221-9360	10R-2765
<b>Cylinder Head</b>			20R-2647 (UTN)
<b>Cylinder Pack (Piston &amp; Rod Gp)</b>			10R-6007
<b>Engine Oil Cooler</b>		133-0125	0R-9056
<b>Engine Oil Pump</b>		161-4113	0R-9449
<b>Fuel Injector</b>		355-6110	
<b>Fuel Transfer Pump</b>		384-8612	20R-1525
<b>Rocker Arms</b>		437-3861	20R-3322
		437-3863	20R3318
<b>Turbocharger</b>		483-0845	
<b>Water Pump</b>		352-0211	10R-0484
<b>Alternator</b>		249-0313	10R-9097
<b>Starter Motor</b>		349-6530	20R-1312

MAJOR COMPONENTS			
Item	Prefix	Standard	Reman
<b>Equalizer Bar</b>	MB8, JJ5	2226926	10R9155
		2604695 (LGP)	20R0081 (LLGP)
<b>Fan Motor</b>		5093040	
<b>Fan Pump</b>		2042578	10R6126
<b>Final Drive</b>		3365750	0R2310
		3367870 (LGP)	20R5590 (LGP)
<b>Final Drive Spindle</b>		3909923	0R2224
<b>Implement Pump</b>		4779824	
<b>Pivot Shaft</b>		8E2837	10R9166
<b>Product Link (PL641 - Cellular)</b>		4402105	20R5677
<b>Product Link (PL631 - Satellite)</b>		4427199	20R5675
<b>Product Link (Network Mgr)</b>		4590786	20R6220
<b>Steering Motor</b>		2525127	10R4579
<b>Steering Pump</b>		3259788	20R7025
<b>Torque Converter</b>		3875630	20E6120
<b>Transmission</b>		3844149	
<b>Transmission Oil Cooler</b>		4W9822	0R5549
<b>Engine</b>		456-6589 (Std)	
		456-6597 (Thermal)	
		456-6598 (EU)	
<b>Camshaft</b>	348-2587	20R-1138	
<b>Connecting rod</b>	224-3245	10R-2117	
<b>Crankshaft</b>	361-8230		
<b>Cylinder Head</b>	345-2207	20R-1016 (UTN)	
<b>Engine Oil Cooler</b>	223-7962	10R-2112	
<b>Engine Oil Pump</b>	161-4113	0R-9449	
<b>Fuel Injector</b>	371-8891	20R-3455	
<b>Fuel Transfer Pump</b>	388-7287	20R-1528	
<b>Rocker Arms</b>	437-3868	20R-3317	
	437-3879	20R-3323	
<b>Turbocharger</b>	450-0528		
<b>Water Pump</b>	366-0168	20R-0952	
<b>Alternator</b>	272-1889	20R-0053	
<b>Starter Motor</b>	349-6530	20R-1312	
<b>Equalizer Bar</b>	5233415 (Std)		
	5233413 (Powered Bottom Guard)		
<b>Fan Motor</b>	5153884		
<b>Fan Pump</b>	3259789		
<b>Final Drive</b>	3365750 (Std)	0R2310	
	1374491 (WHA)	20R7374 (WHA)	
<b>Final Drive Hub</b>	3186248 (Std)		
	1374491 (WHA)	0R2224	
<b>Implement Pump</b>	4957571		
<b>Pivot Shaft</b>	8E2837	10R9166	
<b>Product Link (PL641 - Cellular)</b>	4402105	20R5677	
<b>Product Link (PL631 - Satellite)</b>	4427199	20R5675	
<b>Steering Motor</b>	4892557		

MAJOR COMPONENTS			
Item	Prefix	Standard	Reman
Steering Pump	AW4	5264863	
Torque Converter		4743305	
Transmission		3858824	
Transmission Oil Cooler		4W9822	0R5549

## UNDERCARRIAGE

	Link Assemblies	Track GP					
	44 Sections	22" (560 mm) ES	24" (610 mm) ES	24" (610 mm) Trap ES	24" (610 mm) SES	26" (660 mm) ES	28" (710 mm) ES
General Duty	391-3968	391-3969	–	–	–	–	391-3970
Heavy Duty	272-6009	384-2954	384-2960	384-2962	384-2964	384-2968	–

	Rollers			Sprocket Segments	Idlers	
	Single Flange	Double Flange	Carrier	Tough Steel - 5 Teeth	Rear - Small Diameter	Front - Large Diameter
General Duty	419-7172	–	419-7172	397-9557	415-6134	415-6132
Heavy Duty	246-0775	246-0779	246-0775	314-5462	111-1729	111-1730

ES = Extreme Service    Trap = Trapexoidal    SES = Super Extreme Service

## MIRRORS & LIGHTS

Description	Prefix	Part Number
Lamp GP Flood (Vertical)	MLN, FCT, FMC, J8B, KPZ	153-2073
Lamp GP Flood (Suspended)	MLN, FCT, FMC, J8B, KPZ	219-6487
Lamp Assembly-Dome	MLN, FCT, FMC, J8B, KPZ	226-2811
Lamp GP Flood (Suspended)	MLN, FCT, FMC, J8B, KPZ	227-5978
Lamp GP Flood (HID - Suspended)	MLN, FCT, FMC, J8B, KPZ	332-9402
Lamp GP Flood (2300 LM)	MLN, FCT, FMC, J8B, KPZ	505-8916
Lamp GP Flood (Ripper)	AW4	147-0319
Lamp GP Flood (Rear)	AW4	219-6485
Lamp GP Flood (Service)	AW4	219-6487
Lamp GP Flood (LED)	AW4	383-8634
Lamp (Halogen Bulb)	AW4	351-9918
Lamp - Dome	AW4	7N-9943
Mirror	AW4	5P-6874

## OTHER MISCELLANEOUS

Description	Prefix	Part Number
Cap Assembly - Fuel	MLN, FCT, FMC, J8B, KPZ, MB8, JJ5	349-7059
Camera	MLN, FCT, FMC, J8B, KPZ	347-1668
Camera	J8B, KPZ	459-1800
Padlock	MLN, FCT, FMC, J8B, KPZ, MB8, JJ5	246-2641

## CAB RELATED

Description	Prefix	Standard	40-PSI	Dual Pane
Glass (Door)	MLN, FCT, FMC, AW4	293-0906	222-2825	
Glass (Door)	J8B, KPZ	222-2825	222-2825	
Glass (Door)	MB8, JJ5	379-6657		
Glass RH (Door)	MLN, FCT, FMC, J8B, KPZ, AW4			389-7522
Glass RH (Door)	MB8, JJ5			389-0856
Glass LH (Door)	MLN, FCT, FMC, J8B, KPZ, AW4			389-7521
Glass LH (Door)	MB8, JJ5			389-0855
Glass (Front)	MLN, FCT, FMC, AW4	336-1508	248-4141	389-7520
Glass (Front)	J8B, KPZ	222-2824	222-2824	389-7520
Glass (Front)	MB8, JJ5	383-6864		390-3151
Glass (Rear)	MLN, FCT, FMC, AW4	336-1511	348-4142	389-7525
Glass (Rear)	J8B, KPZ	222-2828	348-4142	389-7525
Glass (Rear)	MB8, JJ5	383-6865		390-3154
Glass (LH Side-Fixed)	MLN, FCT, FMC, J8B, KPZ			389-7524
Glass (LH Side-Fixed)	MB8, JJ5	447-0307		390-3152
Glass (RH Side-Fixed)	MLN, FCT, FMC, J8B, KPZ			389-7523
Glass (RH Side-Fixed)	MB8, JJ5	447-0301		390-3153
Glass (LH Side-Sliding)	MB8, JJ5	447-0316		
Glass (RH Side-Sliding)	MB8, JJ5	447-0310		
Glass (Side-Fixed)	MLN, FCT, FMC, AW4	344-2123	348-4143	
Glass (Side-Fixed)	J8B, KPZ	271-5056	280-2751	
Glass (Side-Sliding)	MLN, FCT, FMC, AW4	344-2124		
Glass (Side-Sliding)	J8B, KPZ	271-5054		
Radio - AM/FM	MLN, FCT, FMC, J8B, KPZ		462-9619	
Radio - AM/FM	AW4		443-8462	
Radio Antenna	MLN, FCT, FMC, J8B, KPZ, AW4		8E-1118	
Seat Belt	MB8, JJ5, AW4		381-4538	
Wiper Blade Assembly (Doors)	MB8, JJ5		6V-5849 or 8C-5060 (Kit contains 2 blades)	
Wiper Blade Assembly (Front)				
Wiper Blade Assembly (Doors)	AW4		(4) 128-5040	
Wiper Blade Assembly (Front)	AW4		6V-5849	
Wiper (Rear)	MB8, JJ5		146-6433	
Wiper (Rear)	AW4		6W-3924	



# Cat Filters Provide Longer Injector Life

Chances are, you don't skip oil changes or regular maintenance on the family car. So why skip planned maintenance on your Cat equipment? Cat fuel filters outperform the competition, with up to 45% longer injector life and up to 80% decreased cost per hour.\*



# Productivity & Hydraulics Go Hand In Hand

If your hydraulic system isn't performing at peak efficiency, it's robbing your machine of performance. Efficiency losses usually occur slowly and can reach 20% before you detect a problem — that's one day of lost production every week! These losses can also increase your fuel consumption and operating costs.



# Need help?

Your local Cat dealer can provide:

- Technical Support
- Customer Value Agreements
- Oil sample analysis
- Parts needed and equipment fit
- Repair financing
- Rental Services

Find your local dealer at [www.cat.com](http://www.cat.com) today.



# LET'S DO THE WORK.™



To buy Cat parts online, visit [Parts.cat.com](http://Parts.cat.com) if you have a dealer account or [MyParts.cat.com](http://MyParts.cat.com) (US only) if you don't yet have an account.

\* Visit <https://www.cat.com/filtersandfluids> for more details

